

STANDING & RUNNING TRIM

SECTION
300

Section 300 Selection and Specification Checklist

Because most architecture, specification, and design firms have electronic master specifications in place, the AWI and AWMAC offer this quick checklist. A review of these items may help the design and specification team issue a complete and accurate contract document and avoid missing things vital to the successful completion of the project. The checklists are not considered a part of the Quality Standards for the purposes of compliance.

Part 1. GENERAL

1.1. REFERENCES

- A. AWI/AWMAC Quality Standards Illustrated (QSI), current edition

1.2. SUBMITTALS

A. Shop drawings:

- Submit two copies; one of which will be returned with reviewed notations prior to commencement of work under this section.
- Indicate plans and elevations, materials, surface grain directions, profiles, assembly methods, joint details, fastening methods, accessories, hardware, compliance with specified fire-retardant treatments, preservative treatments, and schedule of finishes.

B. Finish samples:

- When appropriate, submit one or more samples of veneer-on-substrate, 200 x 250 mm [8 x 10"] illustrating expected range of component finish color and/or grain.
- When appropriate, submit one or more samples of solid lumber, 300 square centimeters [50 square inches] illustrating expected range of component finish color and/or grain.
- The sample shall bear identification of the project, architect or designer, general contractor, woodwork manufacturer, items to which the finish applies and the system utilized to attain the finish.

1.3. QUALITY ASSURANCE

- A. Perform work in accordance with [Premium] [Custom] [Economy] Grade quality

- B. Work in this section shall comply with the specified Grade(s) of Work and Section (s) of the current edition of the AWI/AWMAC Quality Standards Illustrated.

1.4. QUALIFICATIONS

- A. Contractors and their personnel engaged in the work shall be able to demonstrate successful experience with work of comparable extent, complexity and quality to that shown and specified.

- B. Manufacturers who are members in good standing of the Architectural Woodwork Institute (AWI) or the Architectural Woodwork Manufacturers Association of Canada (AWMAC) and are familiar with this Standard.

1.5. DELIVERY, STORAGE AND HANDLING

- A. Protect work from moisture damage according to QSI, Section 1700, Installation.

Part 2. PRODUCTS

2.1. MANUFACTURERS

- A. Manufacturers who are members in good standing of the Architectural Woodwork Institute (AWI) or the Architectural Woodwork Manufacturers Association of Canada (AWMAC) and are familiar with this Standard.

2.2. LUMBER

- A. Softwood Lumber: If a particular species is desired, specify here.

- For exposed surfaces:
- For semi-exposed surfaces:
- For concealed surfaces:

- B. Hardwood Lumber: If a particular species is desired, specify here.

- For exposed surfaces:
- For semi-exposed surfaces:
- For concealed surfaces:

2.3. PANEL PRODUCTS

- A. Softwood plywood: Not usually used for in fine architectural woodwork, but specify here if part of the design aesthetic.
- For exposed surfaces:
 - For semi-exposed surfaces:
 - For concealed surfaces:
- B. Hardwood plywood: Made with medium density particleboard or fiberboard (MDF) core for interior use or moisture-resistant core stock for exterior use; specify face veneer species here.
- For exposed surfaces:
 - For semi-exposed surfaces:
 - For concealed surfaces:
- C. High-pressure decorative laminate (HPDL), specify by brand name and design name/part number.
- For exposed surfaces:
 - For semi-exposed surfaces:
- D. Core material for veneered or laminated components, if other than QSI standards:
- For exposed surfaces:
 - For semi-exposed surfaces:
- E. Solid surface materials, Thermoplastic sheets, Acrylic or methacrylate sheets, Solid phenolic core, or any other special panel product, specify by brand name and design name/product number.

2.4. WOOD TREATMENT

- A. List the specific local requirement for fire retardant treatment, if any.
- B. List the specific chemical and process for preservative treatment, if any.

2.5. GLAZING, HARDWARE, AND ACCESSORIES

- A. If glass is to be supplied by woodworker, the materials and requirements should be listed here.
- Wood stops shall conform to the QSI for the Grade of Work specified.
 - Finish coats on glazed exterior work, if any, shall be allowed to flow on to the glass.
- B. Fasteners: Size and type to suit application. Weather resistant if exterior. The QSI does not set standards for fasteners.
- C. Hardware, if not specified by brand name and part number, shall be mill option to meet QSI minimums.

2.6. FABRICATION

- A. Fabricate to [Premium] [Custom] [Economy] Quality Standards.
- B. Shop prepare and identify components of assemblies for matching during site assembly.
- C. When necessary to cut and fit on site, provide materials with ample allowance for cutting. Provide trim for scribing and site cutting.
- D. Select a joinery technique, or leave it up to the manufacturer to choose from QSI compliant methods.

2.7. FINISHING MATERIALS AND APPEARANCE

- A. List the name of the finish system (topcoats) to be used from Section 1500
- B. List the sheen desired: [Flat] [Satin] [Semi-gloss] [Gloss].
- D. List the special or extra steps and/or products to be used, such as bleach, distressing, filler, glaze, shading, stain, toner or washcoats.

2.8. FINISHING REQUIREMENTS

- A. Sand work smooth and set exposed nails [and screws].
 - For opaque finishes, apply wood filler in exposed nail [and screw] indentations and sand smooth.
 - For transparent finishes, use wax or burn-in filler which blends with surrounding color and sheen, often after stain and before final top coat.
- B. When combining wood and laminates or other specialty products, careful consideration must be given to finishing specifications. Responsibility for finish wood parts should be clarified by the design professional here.
- C. Finish work in the factory in accordance with Section 1500.
- D. [Prime paint] [Seal] surfaces in contact with cementitious materials.

Part 3. EXECUTION

3.1. EXAMINATION

- A. Verify adequacy of backing and support framing.
- B. Verify mechanical, electrical, and building items affecting work of this section are in place and ready to receive this work.

3.2. INSTALLATION

- A. Install work in accordance with [Premium] [Custom] [Economy] Grade, Section 1700, QSI.
- B. Set and secure materials and components in place, plumb and level.

3.3. ADJUSTING

- A. Adjust work under provisions of Section [] of the contract documents.
- B. Adjust moving or operating parts to function smoothly and correctly.

3.4. CLEANING

- A. Clean work under provisions of Section [] of the contract documents.

This page is temporarily blank



General Criteria

300-G-1

Scope

Includes:

A. Standing Trim - Custom manufactured items of fixed length such as door and window casings, stops, stools or sills, aprons, etc. These can usually be accomplished with single lengths of wood (depending on species).

B. Running Trim - Custom manufactured items of continuing length (depending on species) such as cornices, fascias, soffits, chair rail, baseboard, shoe moulding, etc.

C. Rails - Custom manufactured rails used on corridor walls of hospitals and nursing homes, etc., and guard rails at glass openings.

D. Board Paneling - Custom manufactured paneling applied in the form of multiple boards.

Excludes:

Non wood, carved, or embossed mouldings. Paper-, vinyl-, or foil-wrapped mouldings. Any structural wood framing or timbers. Sheathing, decking, or planking. Bucks, grounds, stripping, furring, blocking. Any wood member not exposed.

Architectural woodwork manufacturers can provide a wide variety of “standard” profiles. In addition, they can create custom profiles requested by the client or design professional. They are often called upon to duplicate one-of-a-kind mouldings for restoration work. Refer to the Design Ideas area of this standard.

300-G-2

Specification Requirements

GRADE MUST BE SPECIFIED

These standards provide for three grades of work: Premium, Custom, and Economy.

Premium Grade

The grade specified when the highest degree of control over the quality of workmanship, materials, installation and execution of the design intent is required. Usually reserved for special projects, or feature areas within a project.

Custom Grade

The grade specified for most conventional architectural woodwork. This grade provides a well defined degree of control over the quality of workmanship, materials and installation of a project. The vast majority of all work produced is Custom Grade.

Economy Grade

The grade which defines the minimum expectation of quality, workmanship, materials, and installation within the scope of the standards.

Prevailing Grade

When the QSI are referenced as a part of the contract documents and no Grade is specified, Custom Grade standards shall prevail. In the absence of specifications, material shall be mill option lumber or veneers suitable for opaque finish.

300-G-3

Methods of Production

Flat Surfaces:

• **Sawing** - This produces relatively rough surfaces that are not utilized for architectural woodwork except where a “rough sawn” texture or finish is desired for design purposes. To achieve the smooth surfaces generally required, the rough sawn boards are further surfaced by the following methods:

• **Planing** - Sawn lumber is passed through a planer or jointer, which has a revolving head with projecting knives, removing a thin layer of wood to produce a relatively smooth surface.

• **Abrasive Planing** - Sawn lumber is passed through a powerful belt sander with tough, coarse belts, which remove the rough top surface.

Moulded Surfaces:

Sawn lumber is passed through a moulder or shaper that has knives ground to a pattern which produces the moulded profile desired.

300-G-4

Smoothness of flat and moulded surfaces

Planers and Moulders:

The smoothness of surfaces which have been machine planed or moulded is determined by the closeness of the knife cuts. The closer the cuts to each other (i.e., the more knife cuts per inch [KCPI]) the closer the ridges, and therefore the smoother the resulting appearance.

Sanding and Abrasives:

Surfaces can be further smoothed by sanding. Sandpapers come in grits from coarse to fine and are assigned ascending grit numbers. The coarser the grit, the faster the stock removal. The surface will show the striations caused by the grit. Sanding with progressively finer-grit papers will produce smoother surfaces.

300-G-5

Identification of Standing and Running Trim and Rail Parts

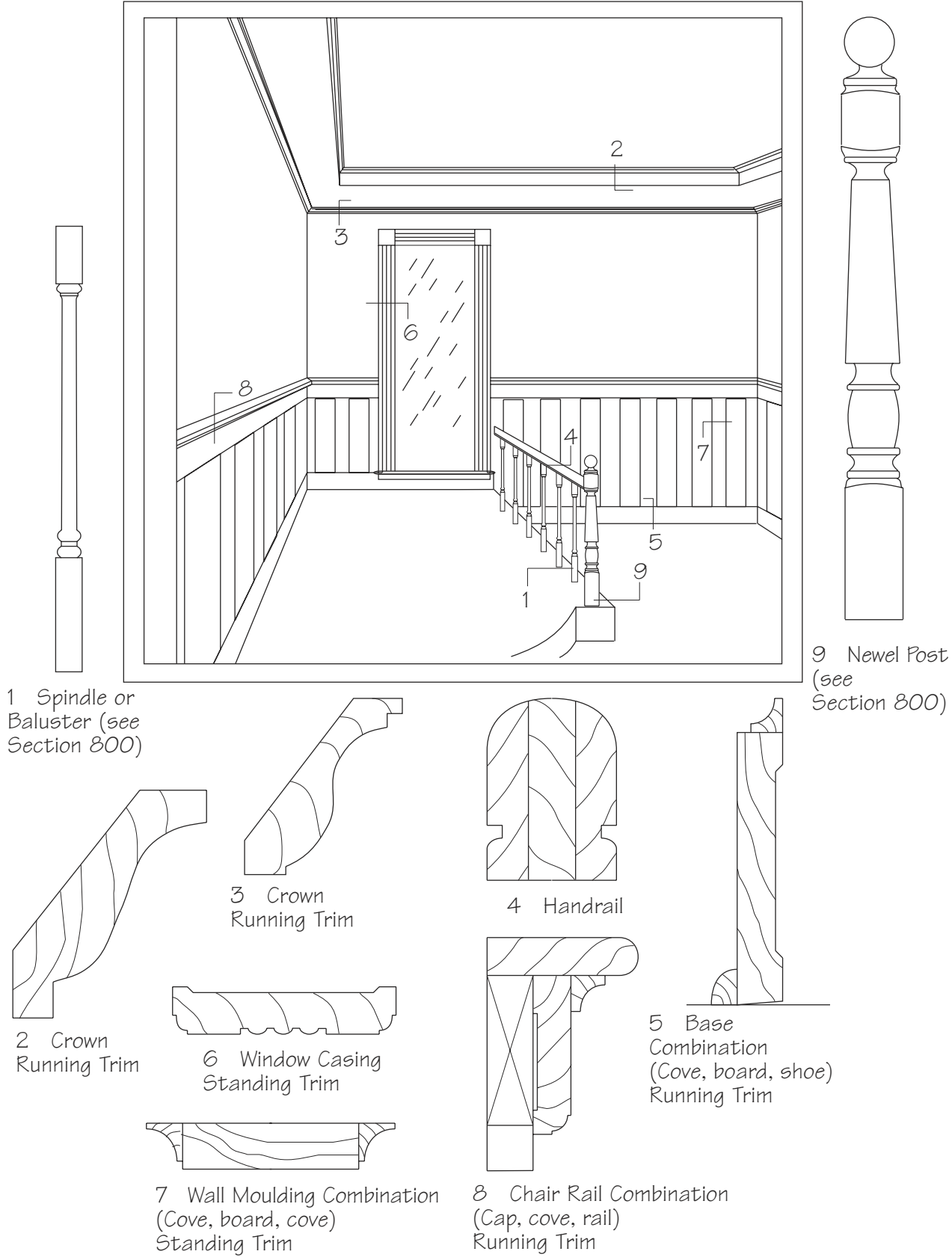

Identification - Figure 300-01

300-G-6

Design and Use of Resources

NOTE: These examples were developed in the Imperial convention, and will not be converted to metric for this edition.

Moulding should be cut from lumber approximately the same size as the finished piece to make the best use of our natural resources.

Designing mouldings with the size of typical boards in mind has several advantages. The typical "1 x 4" will yield a very nice 3/4" thick moulding, but will not be thick enough to develop a moulding which is a full 1" thick in finished dimension. The typical "2 x 4" piece of lumber can be made into mouldings about 1-3/4" thick in a similar manner.

This method also reduces the potential for warp and twist resulting from removing too much of the body of the board.

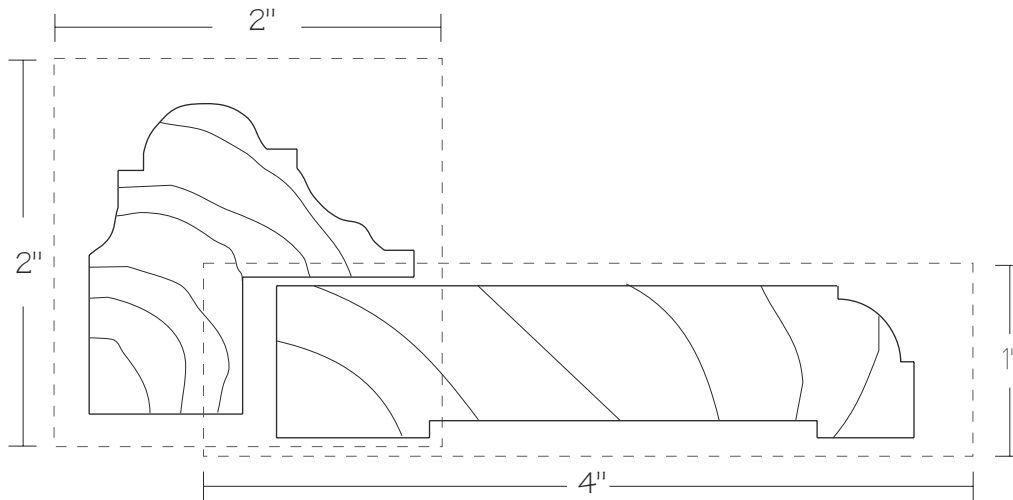
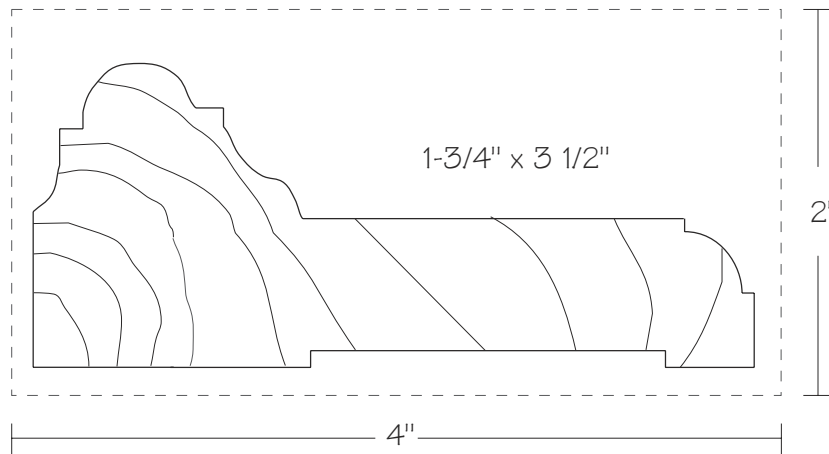
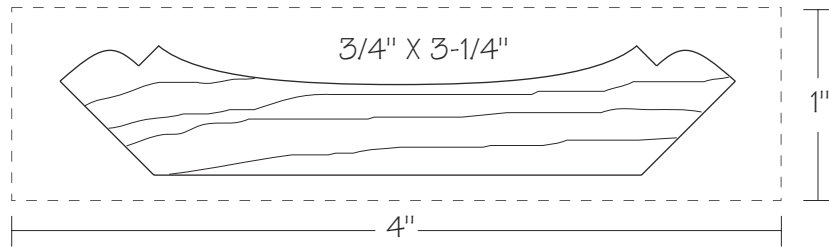

Deep or large mouldings are often best cut from more than one piece and built up to make the final profile. Just as in the manufacture of single mouldings, this process minimizes waste and reduces the tendency of the finished profiles to twist, warp, cup, or bow as a result of removing too much wood from either side of the initial board.

Consult an AWI/AWMAC woodwork manufacturer early in the design process for tips and suggestions on moulding design, fabrication, and installation.

Resource Management - Figure 300-02

300-G-7 Radius Mouldings

Both traditional and nontraditional architectural styles often call for radius standing and running trim either in plan, elevation, or both. In situations where the size of the moulding and the radius to which it is to be formed is such that a straight moulding will not conform to the substrate, the architectural woodworker can use several methods to fabricate radius mouldings. Mouldings applied to radii can be segmented, bent, laminated and formed, pre shaped, or machined to the radius. Woodworkers will fabricate the mouldings in the longest practical lengths, with the purpose of minimizing the field joints.

The architectural woodworker frequently uses band sawing for fabricating radius mouldings. With this technique, the woodworker starts with a large, often glued-up piece of material and band saws to get a curved piece. In order to cut down on waste, the woodworker tries to get several curved pieces from one large piece by nesting, as shown in Illustration A. Characteristically, this method of fabricating radius mouldings limits the length of pieces that can be developed without a joint. It also yields a piece of material with grain straight on the face, not following the curve.

When dealing with profiles with a flat face (see Illustration B,) the woodworker may saw the pieces from a sheet of plywood and then apply an edge band. This will yield larger pieces with more consistent grain.

Another technique for fabricating a radius mould involves laminating thin, bendable plies of lumber in a form (see Illustration C.) Laminated pieces hold their shape without being secured to another surface. This curved piece will then be milled to the desired profile. The glue lines follow the edge

grain and the curve, thus minimizing their visibility. The species of wood and the tightness of the radius determine the maximum thickness of each ply.

When dealing with some cross sections, it can be advantageous to combine band sawing and laminating. The woodworker band saws a core of common lumber and laminates finish material to the exposed faces. From looking at Illustration D, it is apparent that this technique must be limited to certain profiles. It does, however, offer the ability to minimize glue joints and control grain directions. Finally, the simplest method for obtaining a radius moulding is kerfing.

As seen in Illustration E, kerfing consists of making repeated saw cuts on the back face of the piece, perpendicular to the bend. The tightness of the radius determines the spacing and depth of the kerfs. Kerfing allows the piece to be bent to the required radius, and then secured in place to hold the bend. Kerfing almost always results in "flats" on the face which show in finishing. When dealing with a large radius, it is sometimes possible to stop the kerf prior to going through an exposed edge. In most cases, however, the kerf runs all the way through, and the edge must be concealed.

Unless specifically called out, the architectural woodworker will have the option of which method to use for fabricating radius moulding. Since the fabrication method determines the final appearance of the pieces, especially regarding the direction of grain and visibility of glue joints, the architect or designer may wish to specify the method. It is recommended that an architectural woodwork firm be consulted before making a selection. Mock-ups may be required to visualize the end product.

300

Some acceptable methods of radius fabrication

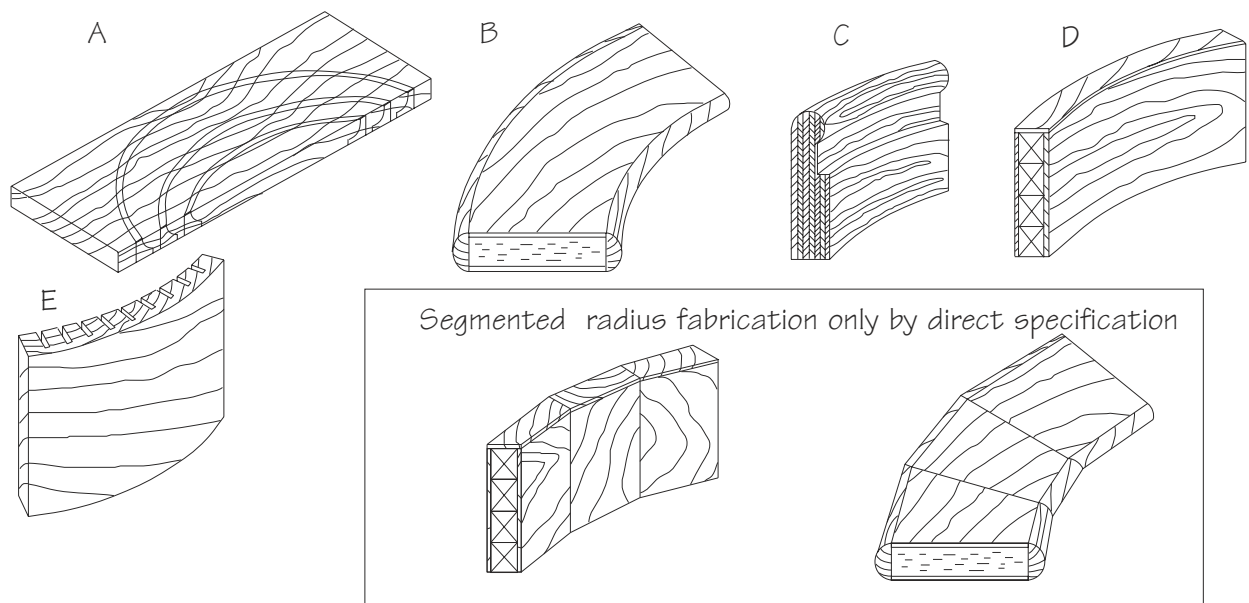

Radius Work - Figure 300-03

300-G-8

Solid Lumber Paneling Patterns

The variety of solid lumber paneling is only limited by the imagination of the design professional. Virtually any machinable profile can be custom manufactured. The following profiles are some of the traditional patterns associated with solid board paneling. They are not dimensioned intentionally, allowing the design professional to determine the scale and proportions most appropriate for the project.

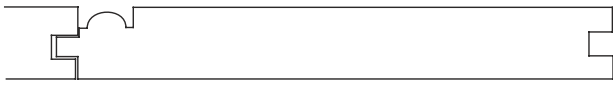

Single Bead



Beaded Ceiling or Wainscot



Some Reveal Detail Options

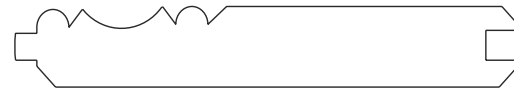

Pickwick Paneling



Tongue and Groove "V" Joint



Beaded Siding

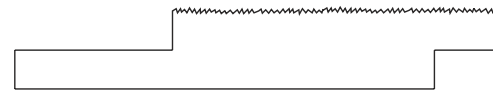

Rough Sawn Reveal



Simulated Lap Siding



Bevel Siding with plough



Drop/Lap Siding



Moulded Insert



Beaded Bevel Siding



Coved Paneling

Board Paneling Examples - Figure 300-04

300



Technical Criteria

300-T-1

Specification Requirements

Architect or Design Professional shall ...

- specify the Grade required;
- specify the species and type of cut;
- specify the type of moulding or trim;
- specify the ornamental details and joinery which affect the aesthetics and function;
- specify the fire retardant rating, if required; and
- specify the preservative treatment for exterior use, if required.

300-T-2

Materials

Hardwood members exceeding dimensions defined in Section 100 may be glued for width and thickness.

If total length exceeds the available length of the species as defined in Section 100, members can have plant-prepared joints for field assembly. Unless otherwise specified or detailed, the following standards shall apply:

	Premium		Custom		Economy	
	Transparent	Opaque	Transparent	Opaque	Transparent	Opaque
Lumber Grade	I	II	II	II	II	II
Cut of Lumber	Plain sawn	Plain sawn or MDF	Plain sawn	Plain sawn or MDF	Plain sawn	Plain sawn or MDF

300-T-3

Workmanship

	Premium	Custom	Economy
Finger-jointed lengths	Not permitted	Not permitted	Permitted
Exposed end (Return)	Plant made	Not required	Not required
With non-exposed ends*	Backed out	Backed out	Flat back
Plant assembly of trim members (Must be specified)	Lemon Spline, Butterfly, Scarf or Dowel	Clamp nails or Lemon spline, Butterfly, Scarf or Dowel	Not required
Factory manufactured radius mouldings	Factory shaped and glued to longest practical lengths, for installation with smooth transitions.		Not required
Minimum lengths	Lengths of trim pieces are governed by material availability. Consult Section 100 for data.		

* Note: Door and window trim with non-exposed ends shall be backed out in Premium and Custom Grades when the width exceeds 2 inches. Other trims are backed out at manufacturer option.

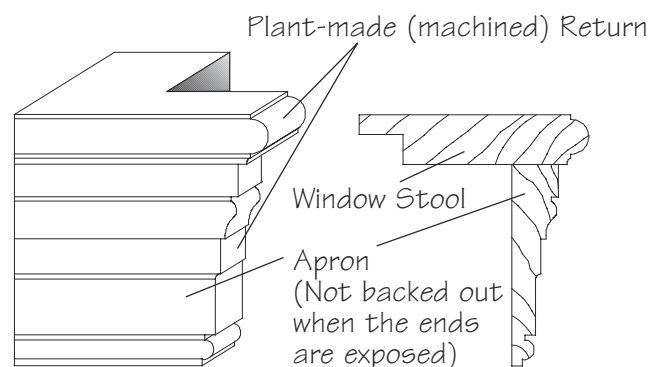

Machined Return - Figure 300-05

300-T-4

Smoothness of Exposed Surfaces

Smoothness Table	Premium		Custom		Economy	
	Transparent	Opaque	Transparent	Opaque	Transparent	Opaque
Sharp edges (Arris)	Eased with fine abrasive		Eased with fine abrasive		Mill option	
Top flat surfaces	150 grit		120 grit		100 grit or 15 KCPI	
Moulded surfaces	120 grit		minimum 20 KCPI			
Shaped surfaces	120 grit		minimum 20 KCPI			
Turned surfaces	120 grit		100 grit			
Sanding cross scratches	None allowed	Not to exceed 6.4 mm [.25"]	None allowed	Not to exceed 6.4 mm [.25"]		

NOTE: No tearouts, knife nicks, or hit-or-miss finish allowed. No knife marks allowed where sanding is required. Surface variations as a result of multiple tool passes treated as turned surfaces above. Glue and filler, if used, must be inconspicuous and sanded as smoothly as the surrounding surface. Sanding before final stain and/or finish should be a consistent grit and scratch pattern, as it influences blend of color and sheen between components. Top Flat Surfaces are those which which can be sanded with a drum or wide belt sander. Turnings are customarily sanded on the lathe, and will exhibit cross scratches.

Before finishing, all exposed portions of architectural woodwork shall have handling marks or effects of exposure to humidity or moisture removed by a thorough uniform final sanding. The sanded surface shall then be cleaned and dust free, prior to proceeding with the first step in the finishing process. Veneer sand-through, with veneer sanded to the point where cross banding or core is visible, and/or core telegraphing (variation from a true plane in excess of 0.25 mm [0.010"] in any 76 mm [3"] span) is not allowed in any Grade.

300

300-T-5

Methods of Plant Assembly of Mitered Joints (must be specified)

PREMIUM: Trim members pressure glued and joined by lemon spline, biscuit, glued lock joint, or dowels.

CUSTOM: Trim members glued and joined by clamp nails. If joint exceeds 101 mm [4"] in length, two clamp nails are required if profile permits.

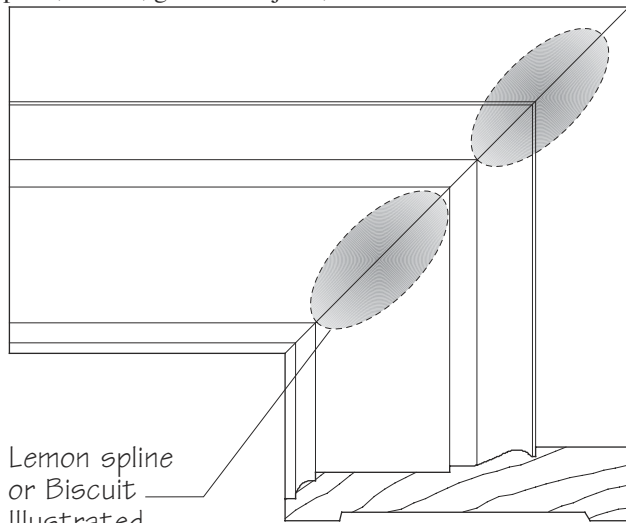

Lemon spline or Biscuit Illustrated

Biscuit Illustration - Figure 300-06

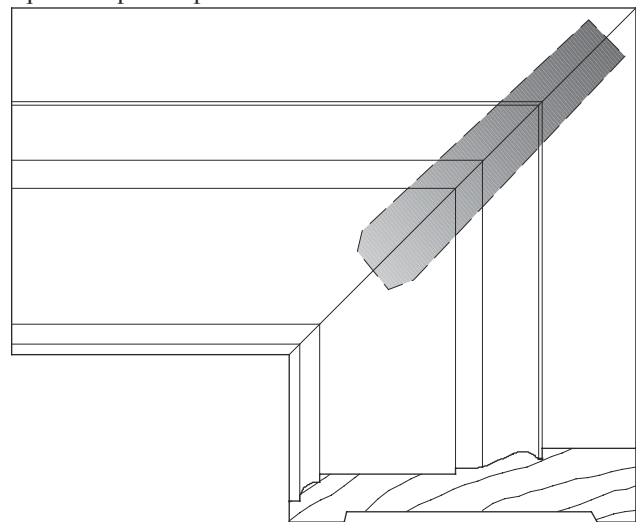

Clamp Nail Illustration - Figure 300-07

300-T-6

Tightness and Flushness of Plant Assembled Joints

Plant Assembled Joint Table	Premium		Custom		Economy	
	Interior	Exterior	Interior	Exterior	Interior	Exterior
Maximum gap: Test A	0.4 mm [.015"] wide by 20% of joint length	0.6 mm [.025"] wide by 30% of joint length	0.6 mm [.025"] wide by 20% of joint length	1.3 mm [.050"] wide by 30% of joint length	1.3 mm [.050"] wide by 20% of joint length	1.9 mm [.075"] wide by 30% of joint length
Maximum gap: Test B	0.4 mm [.015"] x 76 mm [3"], and no gap may occur within 1829 mm [72"] of a similar gap	0.6 mm [.025"] x 152 mm [6"], and no gap may occur within 762 mm [30"] of a similar gap	0.6 mm [.025"] x 152 mm [6"], and no gap may occur within 1524 mm [60"] of a similar gap	1.3 mm [.050"] x 203 mm [8"], and no gap may occur within 660 mm [26"] of a similar gap	1.3 mm [.050"] x 203 mm [8"], and no gap may occur within 1219 mm [48"] of a similar gap	1.9 mm [.075"] x 254 mm [10"], and no gap may occur within 610 mm [24"] of a similar gap
Maximum gap: Test C	0.4 mm [.015"]	0.6 mm [.025"]	0.6 mm [.025"]	1.3 mm [.050"]	1.3 mm [.050"]	1.9 mm [.075"]
Maximum gap between fixed components shall be tested at points designed to join; where members connect or touch.						
Flushness Variation	0.03 mm [.001"]	0.4 mm [.015"]	0.1 mm [.005"]	0.6 mm [.025"]	0.6 mm [.025"]	1.3 mm [.050"]

300

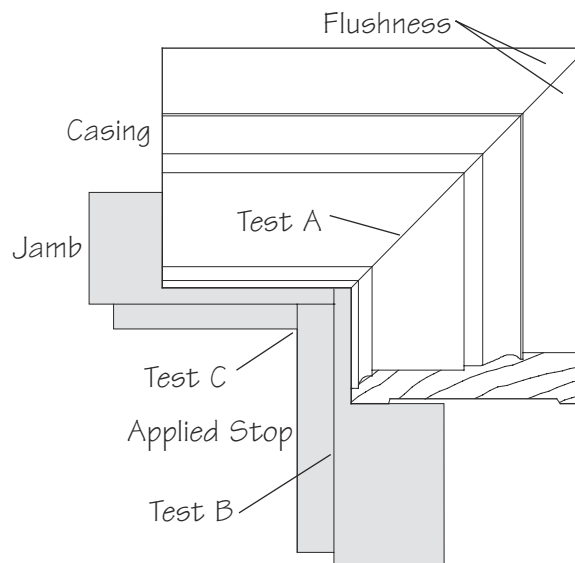

Test Locations - Figure 300-08

300-T-7

Methods of Rail Fabrication

Unless specified otherwise, large dimension rail fabrication techniques are at the option of the woodworker. Some methods include:

“Butcher Block” lamination (300-09)

Face lamination (300-10)

Veneered construction over core (300-11)

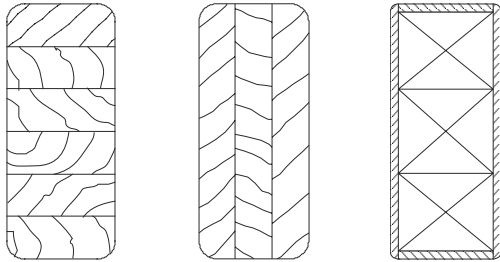
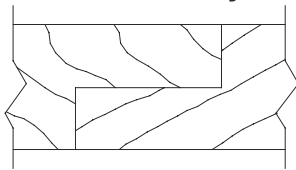

Figure 300-09 Figure 300-10 Figure 300-11

300-T-8

Methods of Plant Assembly of Rails



Half-lap Joint Glued Under Pressure - Figure 300-12

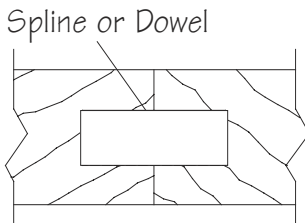

Butt Joint Glued, Reinforced - Figure 300-13

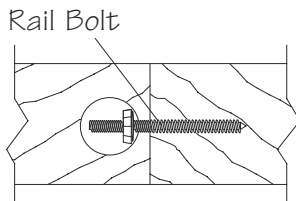

Rail Bolt - Figure 300-14

300-T-9

Selection for Grain and Color

Plant Assemblies:

For Transparent finish, adjacent members of...

- Premium Grade: ...shall be well matched for grain and color.
- Custom Grade: ...shall be compatible for color.
- Economy Grade: ...shall not be selected.

Visible finger joints not permitted in Premium and Custom Grades. No selection for grain or color is required for opaque finish in any Grade.

Field Assemblies:

Selection of adjacent members for compatibility is the responsibility of the installation contractor.

300-T-10

Chord Segmentation on Curves

“Chord segmentation,” the process of cutting short lengths of straight moulding and joining them around a curved substrate (as a chord, intersecting two points on the curve), is never allowed unless specified. Mouldings for curved surfaces should be supplied in the longest lengths practical to minimize joints, and should be laminated and/or machined to approximate the actual curve. (Small, flat profiles may sometimes be bent around gentle curves when the bending does not materially distort the profile.)



Compliance Criteria

300-C-1

Tests for Smoothness of Exposed Surfaces

KCPI (Knife Cuts Per Inch) can be determined by holding the surfaced board at an angle to a strong light source and counting the visible ridges per inch, usually perpendicular to the profile.

SANDING can best be checked by sanding a sample piece of the same species with the required grit of abrasive. Observation with a hand lens of the prepared sample and the material in question will offer a comparison of the scratch marks of the abrasive grit. Reasonable assessment of the performance of the finished product will be weighed against absolute compliance with the standard.

A product is sanded sufficiently smooth when knife cuts are removed and any remaining sanding marks are or will be concealed by applied finishing coats. Handling marks and/or grain raising due to moisture or humidity in excess of the ranges set forth in this standard shall not be considered a defect.

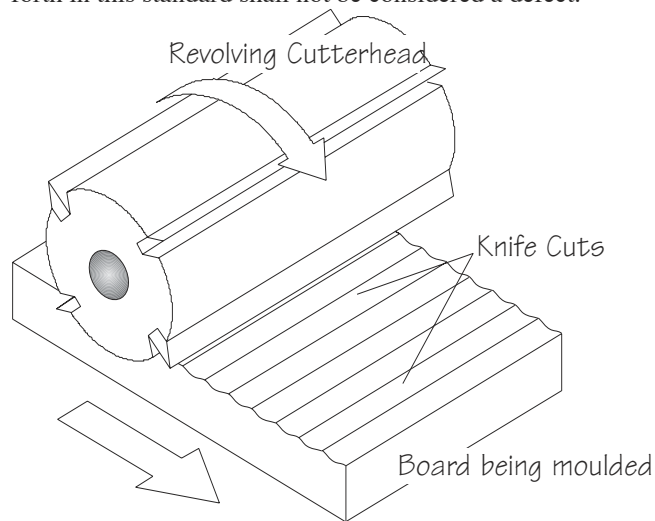

Exaggerated detail of milling process

Milling - Figure 300-15

300-C-2

Tightness and Flushness of Plant-Assembled Joints

Joint tightness and/or flushness will meet the standard when tested with a feeler gauge at the points indicated in the illustration. Joint length will be measured with a ruler with a minimum division of 1 mm [$1/16$ "] and calculations made accordingly. Reasonable assessment of the performance of the finished product will be weighed against absolute compliance with the standards.



Design Ideas

300-D

Freedom of Expression

Custom-designed woodwork gives you complete freedom of expression.

- **Design flexibility:** The use of custom-designed woodwork in a building allows the design professional freedom of expression while meeting the functional needs of the client. A custom-designed building is enhanced by the use of custom-designed woodwork.
- **Cost effective:** Custom woodwork does compete favorably with mass-produced millwork, and offers practically limitless variations of design and material. Most woodwork lasts the life of the building – quality counts.
- **Complete adaptability:** By using custom woodwork, the architect or designer can readily conceal plumbing, electrical and other mechanical equipment without compromising the design criteria.
- **No restrictions:** Custom architectural woodwork permits complete freedom of selection of any of the numerous hardwoods and softwoods available for transparent or opaque finish. Other unique materials available from woodwork manufacturers require no further finishing at all, such as plastic laminates and decorative overlays. These materials can be fashioned into a wide variety of profiles, sizes, and configurations. The owner and design professional have the best of both worlds – high quality and freedom of choice.
- **Dimensional flexibility:** Since custom woodwork is normally produced by a specialty architectural woodwork firm, dimensions can easily be changed prior to actual fabrication, if required by job conditions. Special situations such as designing for the handicapped can readily be accommodated by the custom architectural woodwork manufacturer.
- **Quality assurance:** Adherence to the QSI and specifications will guarantee the design professional of a quality product at a competitive price. Use of a qualified AWI/AWMAC member firm will help ensure the woodworker's understanding of the quality level required.

A Note on Embossed Mouldings

For the most part, custom woodwork manufacturers produce machined moulding profiles. Machined profiles result from passing lumber through cutting knives to shape the profile. Embossed mouldings, on the other hand, are usually produced by pressing a pattern into the face of the wood. While many AWI/AWMAC member firms furnish embossed mouldings, most do not produce them. Embossed mouldings are not illustrated in this book.



Caution

Consult your woodwork manufacturer about moulding dimensions and effective yield from the lumber. In most cases, profiles will have to change slightly as the size of the moulding is changed. Work from full size shop drawings of normal mouldings and large scale shop drawings of very large moulding assemblies. Verify profiles and relationships on the shop drawings before fabrication.

300-D-1

Typical Uses of Standing and Running Trim and Rails

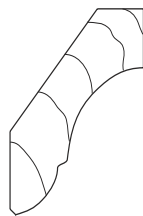
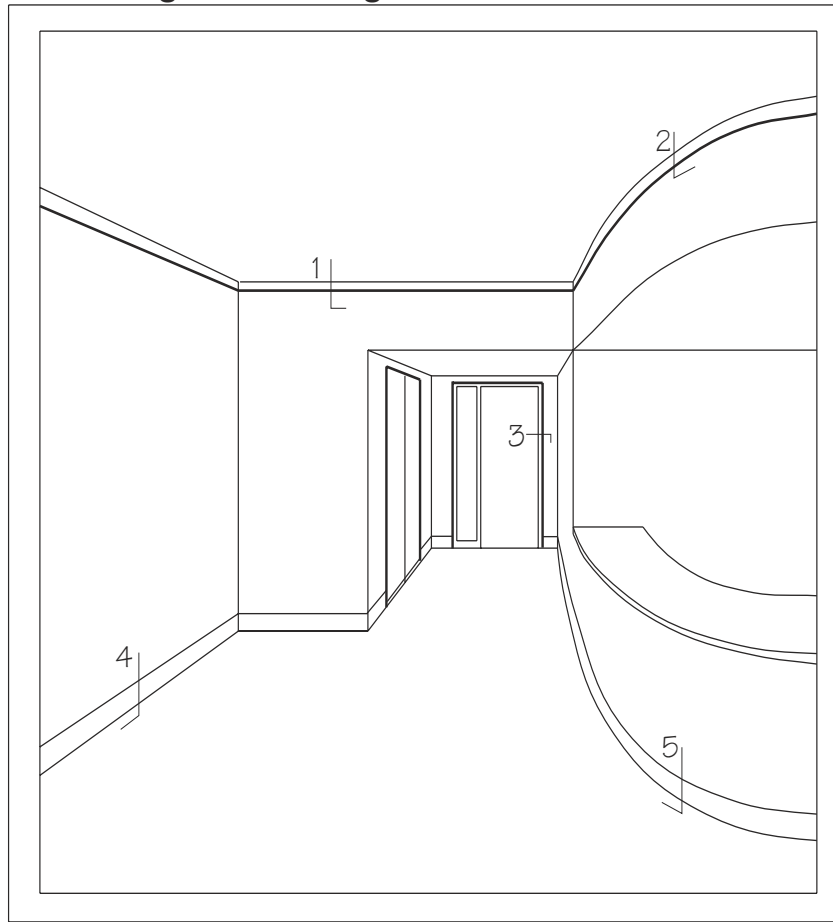

1 Cove (straight)



2 Cove (radius)

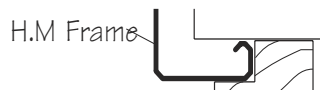

H.M. Frame

3 Back band

Loose
Large Radius field bend;
Small Radius machined
to approximate curve

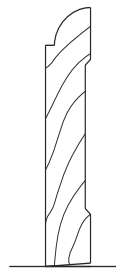

4 Base (straight)



5 Base (radius)

Loose
Large Radius field bend;
Small Radius machined
to approximate curve
Kerf back side for
Large Radius, field bend;
Small Radius machined
to approximate curve

Figure 300-16

300-D-1 (cont.)



300

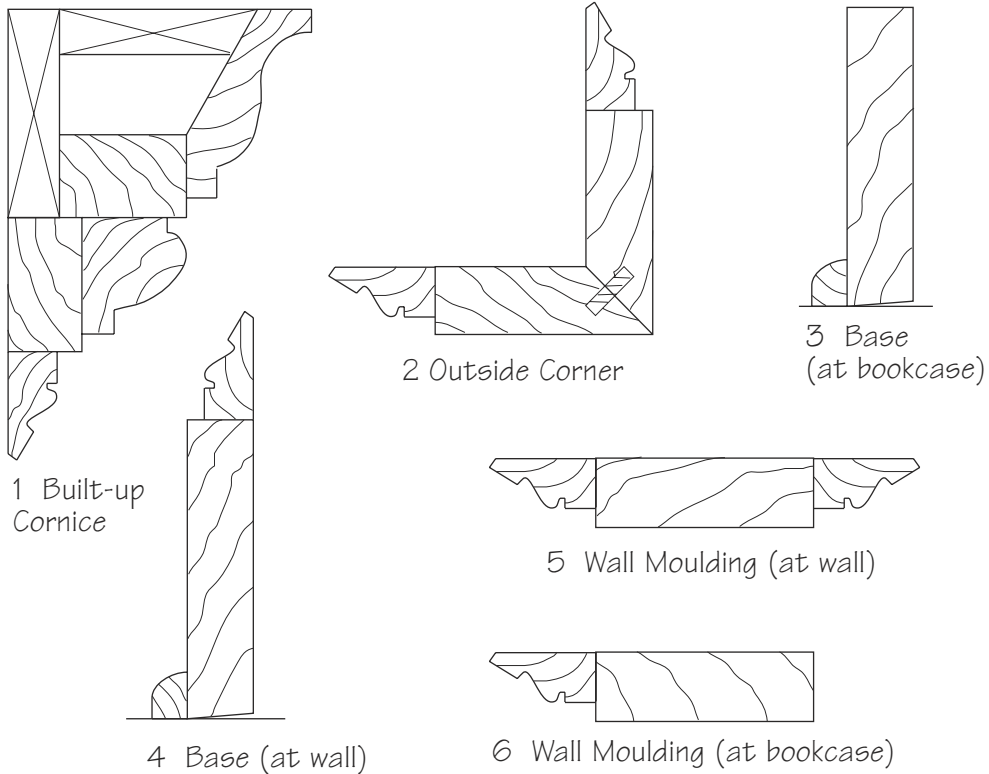
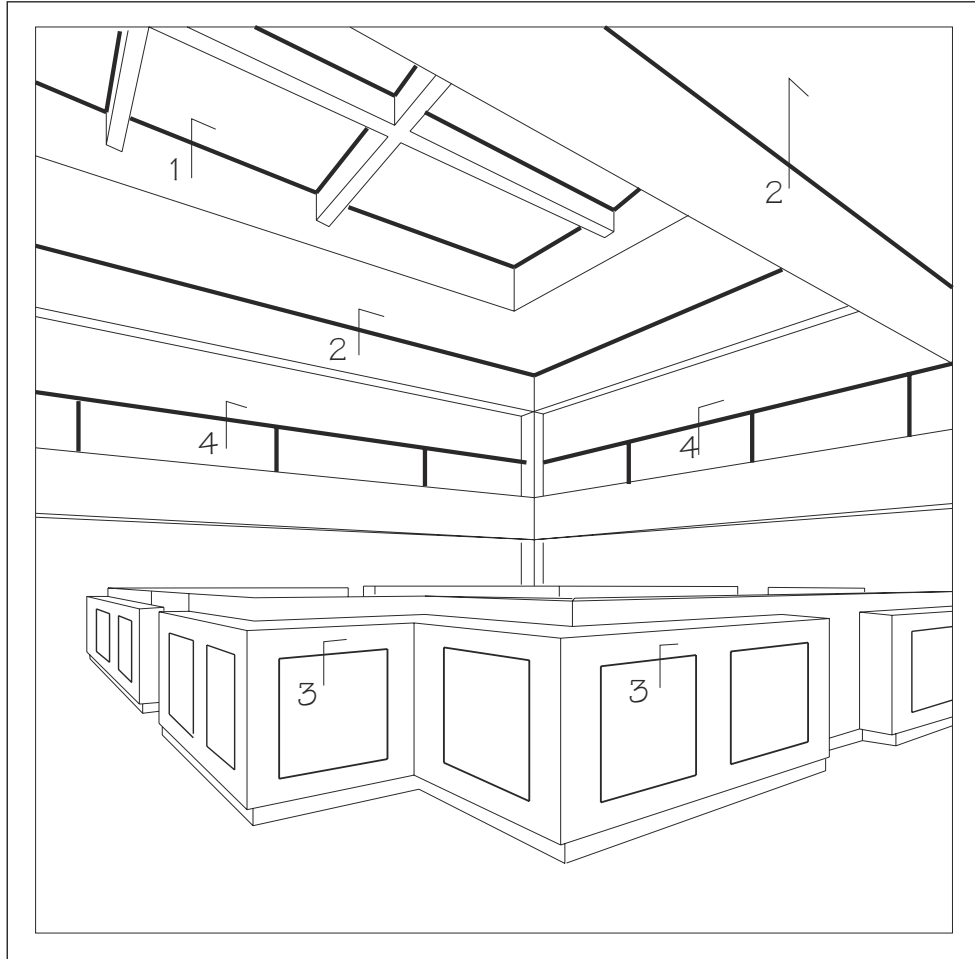
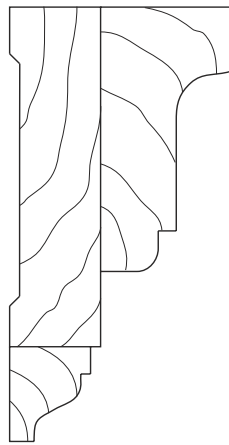

Figure 300-17

300-D-1 (cont.)



300



1 Skylight Cornice

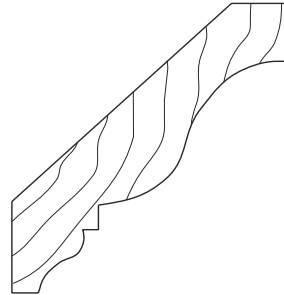

2 Crown



3 Panel Moulding

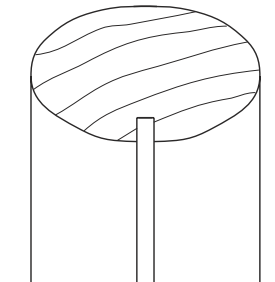

4 Handrail

Figure 300-18

300-D-1 (cont.)

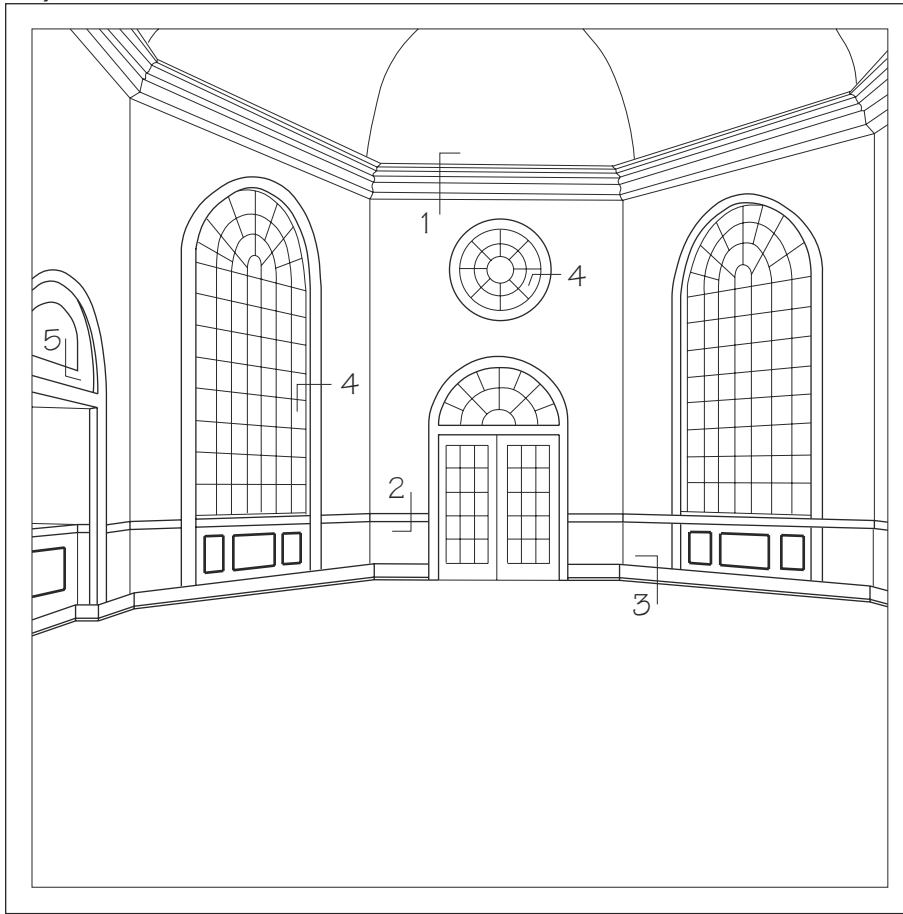

300

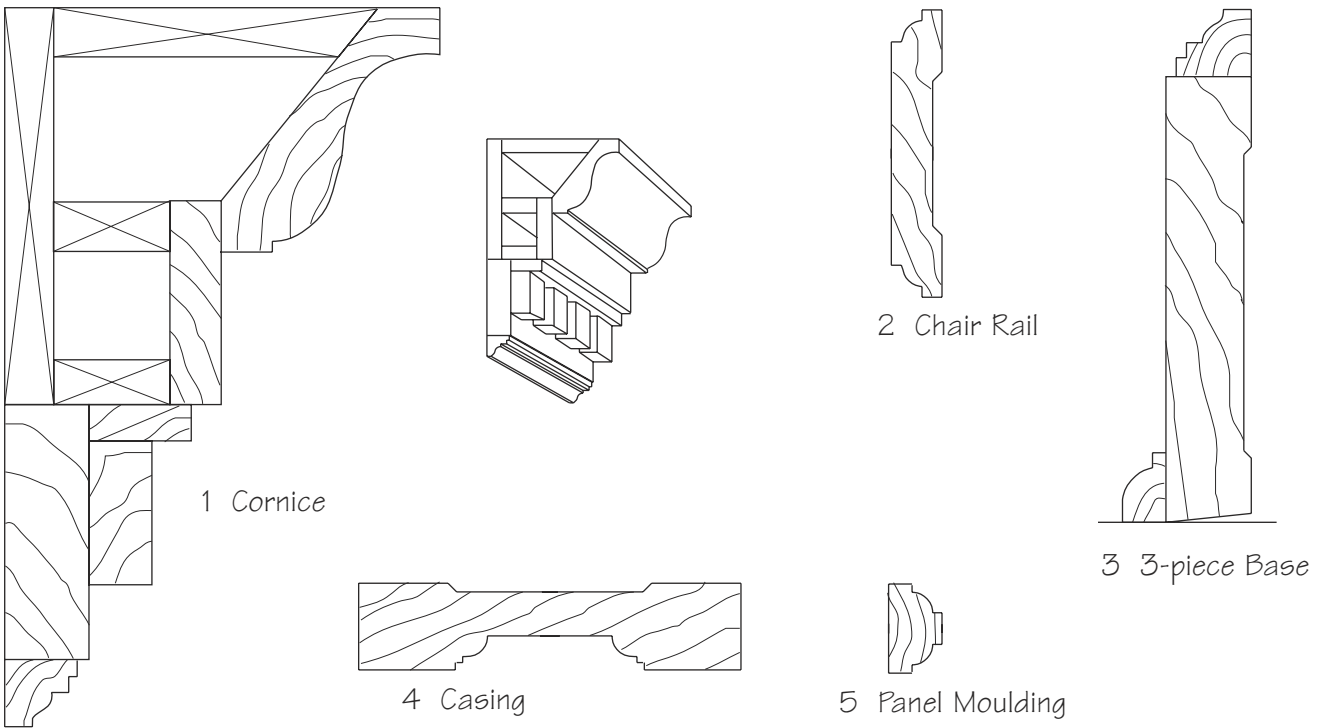

Figure 300-19

300-D-2

“Built-up” Mouldings for Larger Profiles

(Used with permission of the Wood Moulding and Millwork Producers Association.)

Ceilings

The most obvious area for “built-up” mouldings is where the walls meet the ceiling. This is primarily true of rooms with high ceilings. In low-ceiling rooms (8'), single moulding profiles usually work best. A series of “built-up” mouldings would have a tendency to make a low ceiling appear even lower. But if your ceilings are high (10' or higher), there is no limit to the rich three-dimensional elegance you can add to the room’s appearance with the creative application of mouldings. Below are several suggested combinations. Let your imagination create your own combinations and designs.

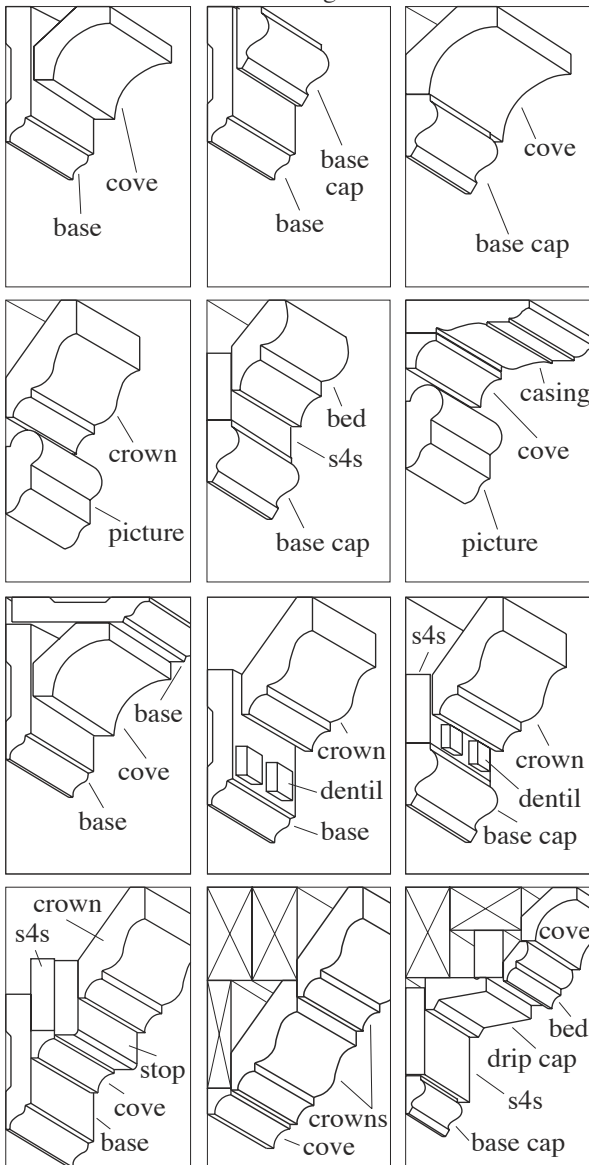
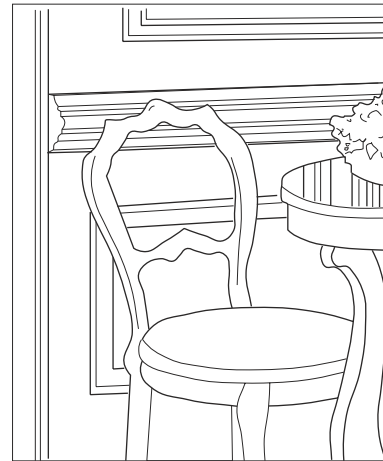

Figure 300-20

Chair Rails



Adding chair rails to a room is a very traditional method of breaking up walls, adding both interest and protection. They prevent the wall from being bumped or scuffed by chairs and can also be used to separate two types of decorating material such as paneling, wallpaper, and paint. Following are some variations of “built-up” chair rail

combinations.

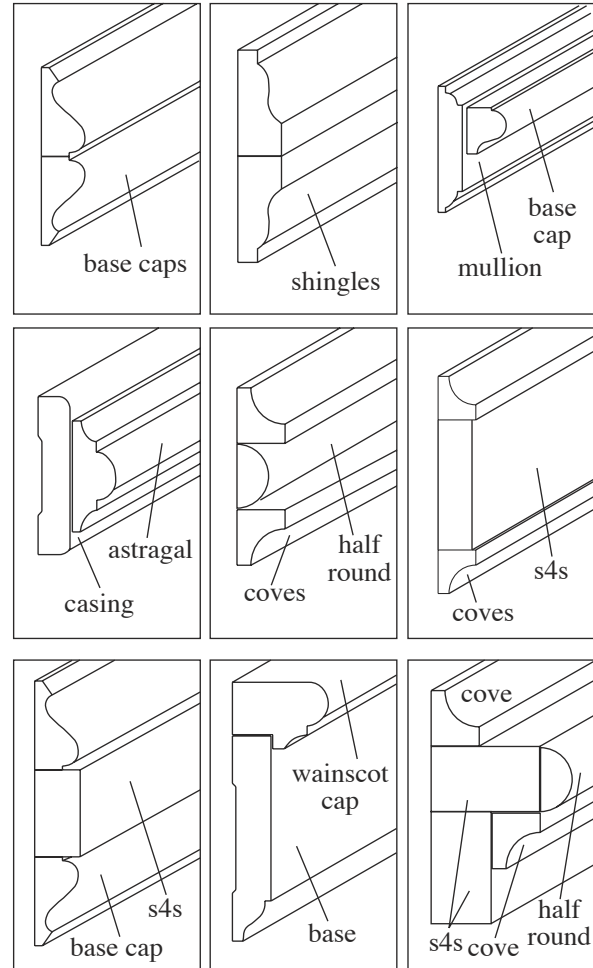

Figure 300-21

300-D-2 (cont.)

Fireplaces

The use of “built-up” mouldings is also an excellent way to highlight or frame a fireplace or add depth and richness to the fireplace mantel. Below are a few creative but simple-to-install profile combinations.

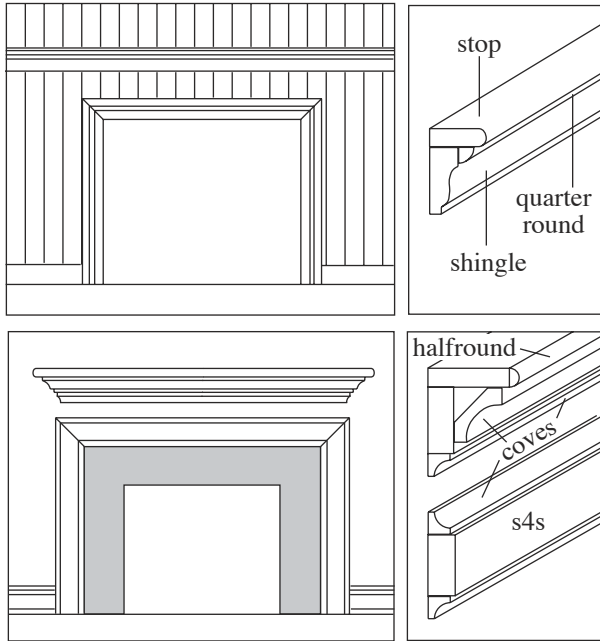

Figure 300-22

Doors and Windows

The framing of doors and windows is most commonly done with single moulding profiles, but by adding other patterns, the basic trim can easily be transformed into a window or door casing of classical depth and beauty. Installing plinth blocks at the bottom of casing further enhances the traditional look.



Figure 300-23

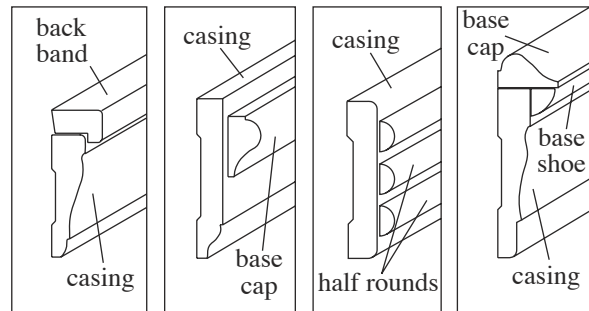

Figure 300-24

Base

The elaborate look of elegance can even be carried through to base mouldings where the wall meets the floor, as illustrated in the following variations.

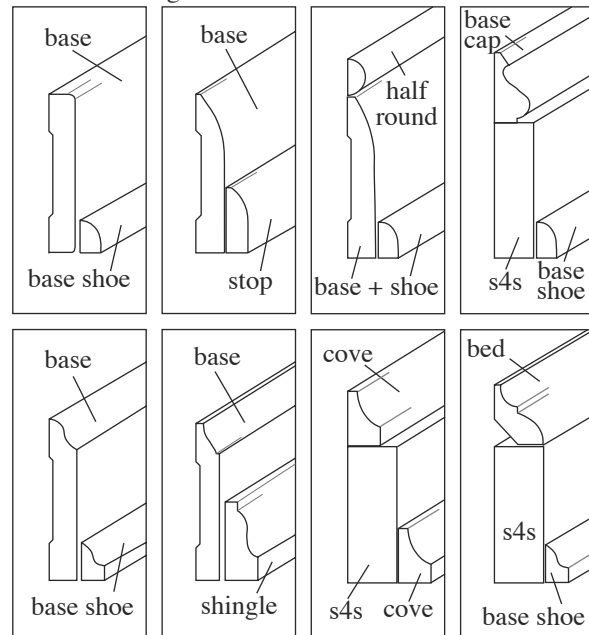

Figure 300-25

300-D-3

Combination Cornices and Wall Trims

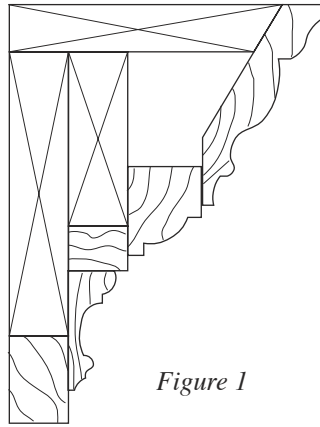

Figure 1

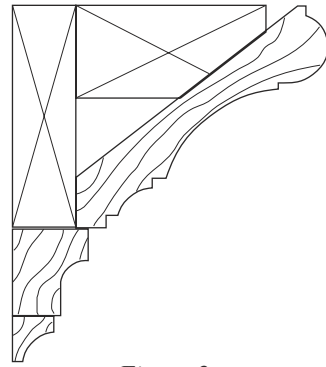

Figure 2

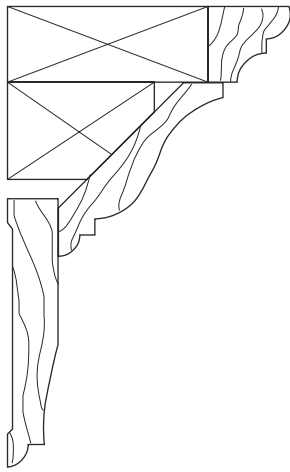

Figure 3

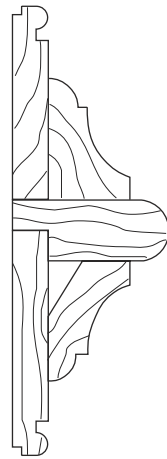

Figure 4

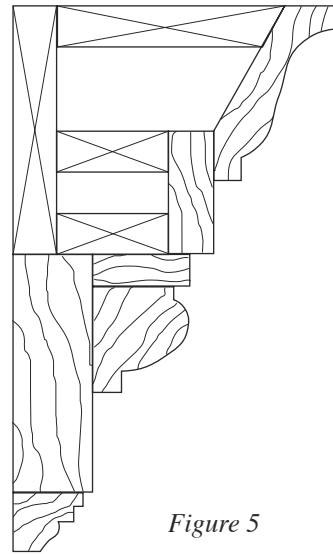

Figure 5

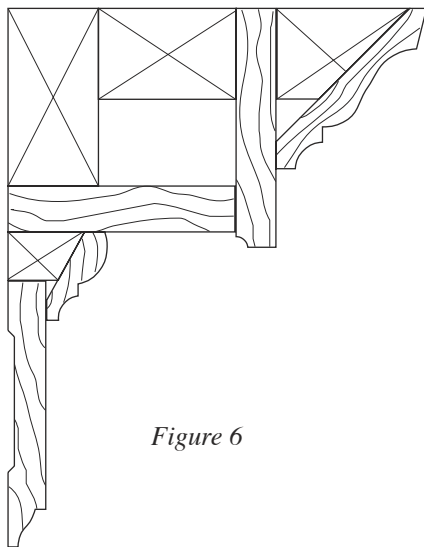

Figure 6

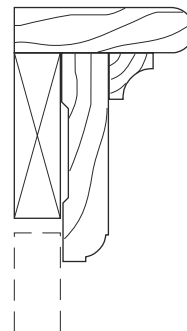

Figure 7

300-D-3 (cont.)

300

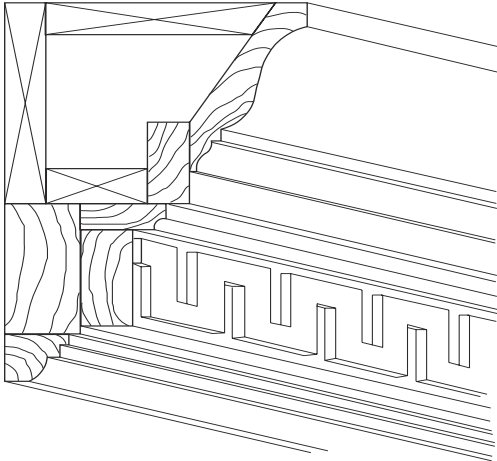

Figure 8

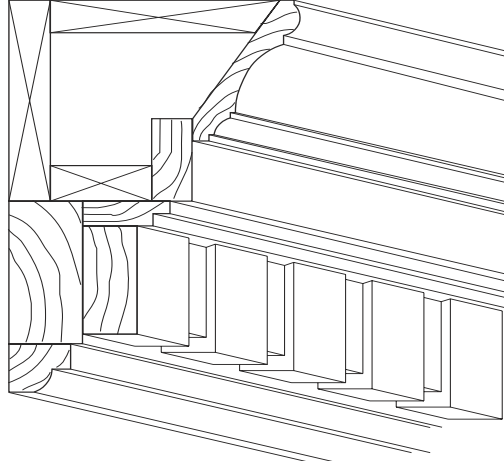

Figure 9

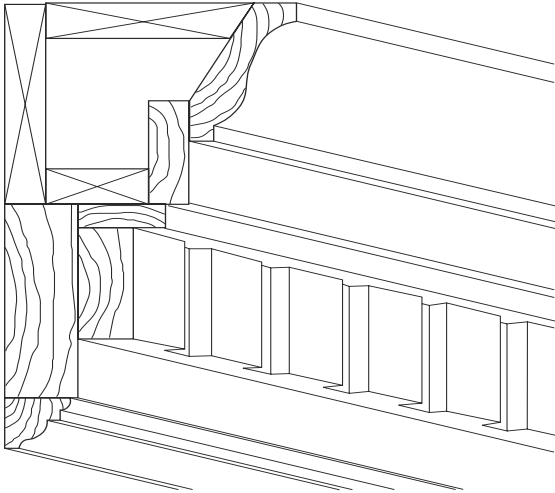

Figure 9

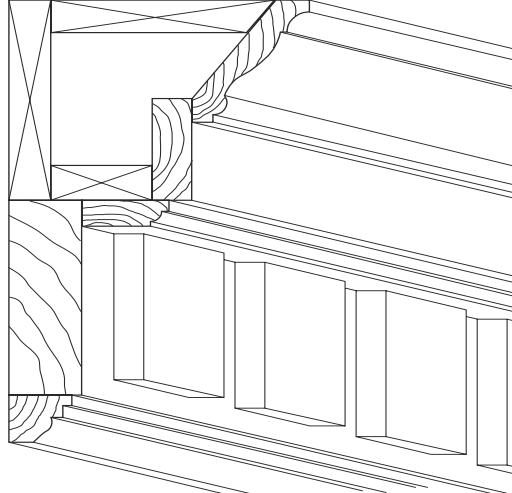

Figure 10

Figure 300-27

300-D-4

Base Caps and Bases

IMPORTANT NOTE: These drawings are illustrations, not measured or engineered. They are offered for general profile shape only. Some manufacturers may vary the profile or sizes. This first page of illustrations are caps, placed on top of other base profiles. They are not dimensioned intentionally, allowing the design professional to determine the scale and proportions most appropriate for the project.

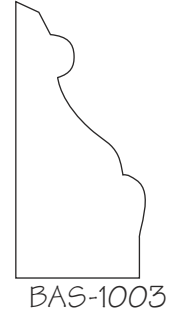
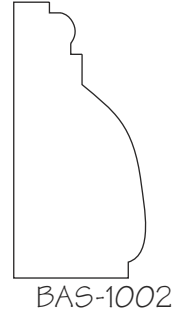
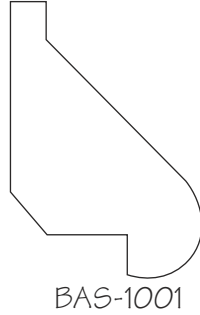
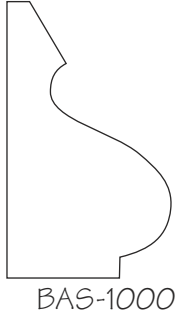

300

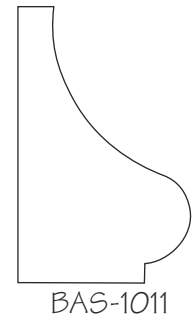
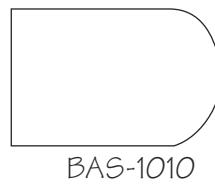
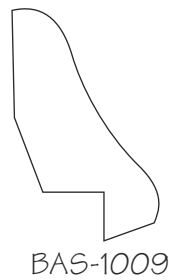
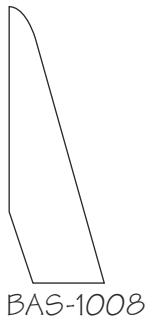
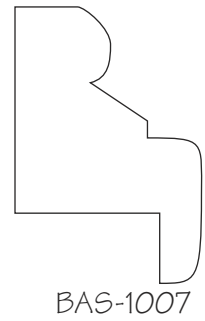
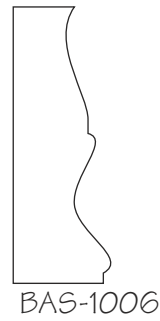
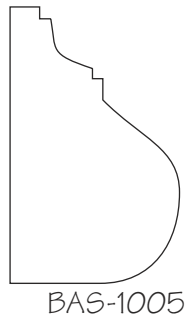
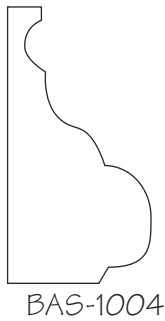

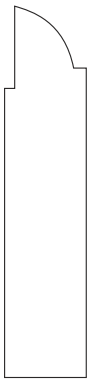

BAS-1012



BAS-1013

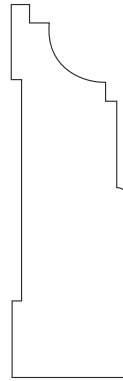

BAS-1014

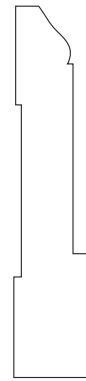

BAS-10015



BAS-1016



BAS-1017



BAS-1018



BAS-1019



BAS-1020



BAS-1021



BAS-1022



BAS-1023



BAS-1024



BAS-1025



BAS-1026



BAS-1027



BAS-1028



BAS-1029



BAS-1030

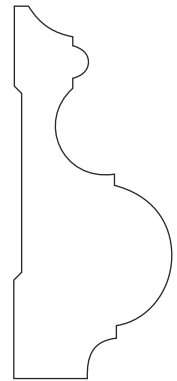

BAS-1031



BAS-1032

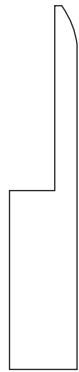

BAS-1033



BAS-1034



BAS-1035



BAS-1036



BAS-1037



BAS-1038



BAS-1039



BAS-1040



BAS-1041



BAS-1042



BAS-1043



BAS-1044



BAS-1045



BAS-1046



BAS-1047

300



BAS-1048

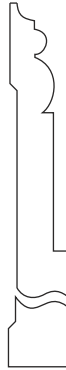

BAS-1049



BAS-1050



BAS-1051



BAS-1052

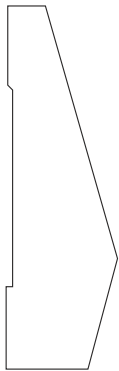

BAS-1053

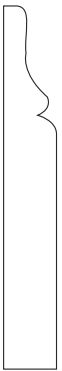

BAS-1054



BAS-1055



BAS-1056

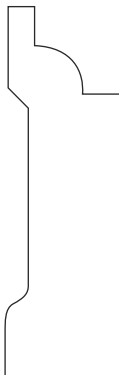

BAS-1057



BAS-1058

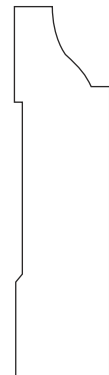

BAS-1059

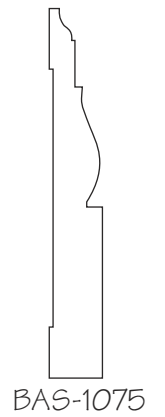
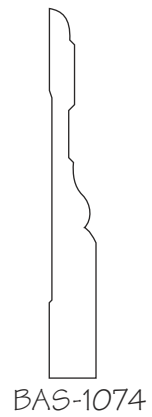
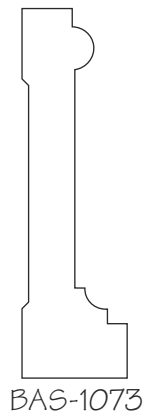
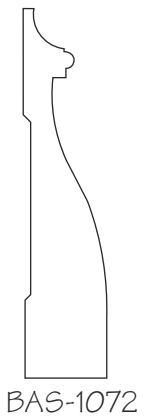
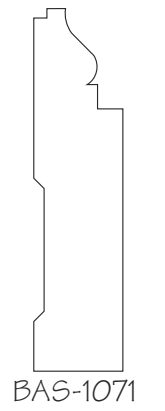
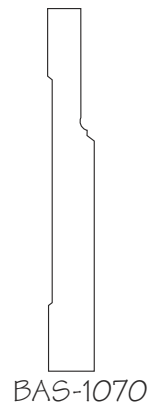
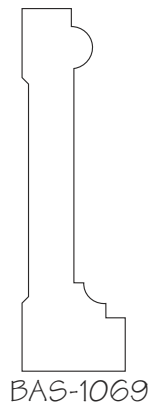
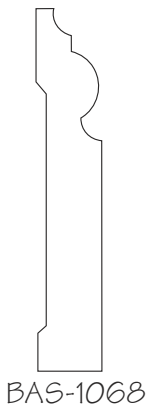
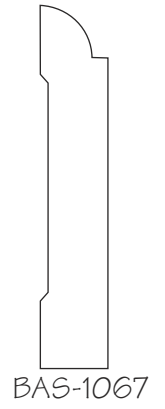
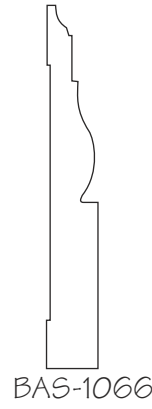
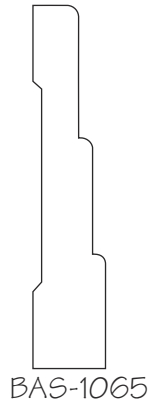
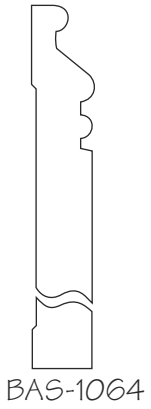
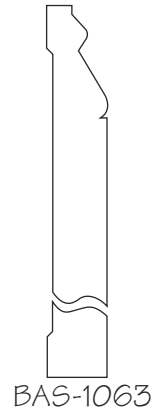
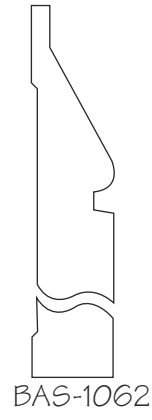
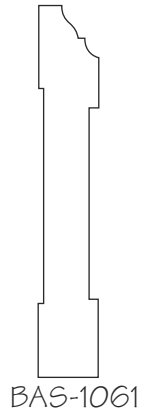
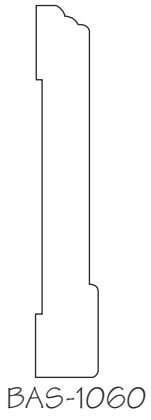

300-D-5

Casings

IMPORTANT NOTE: These drawings are illustrations, not measured or engineered. They are offered for general profile shape only. Some manufacturers may vary the profile or sizes. They are not dimensioned intentionally, allowing the design professional to determine the scale and proportions most appropriate for the project.

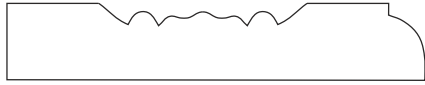

CAS-2000

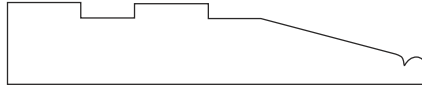

CAS-2001

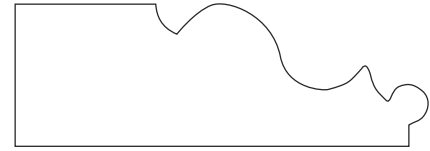

CAS-2002

300

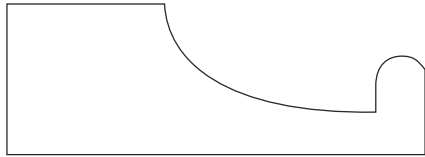

CAS-2003



CAS-2004



CAS-2005

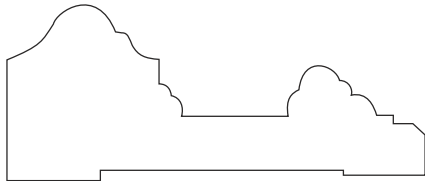

CAS-2006

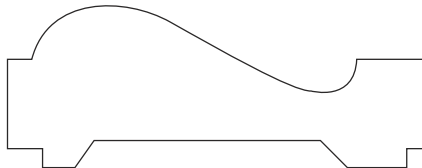

CAS-2007

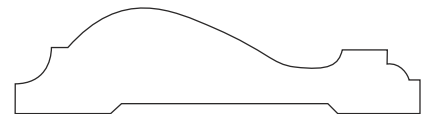

CAS-2008

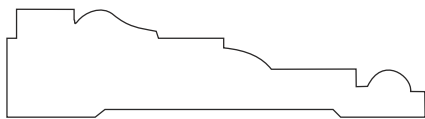

CAS-2009

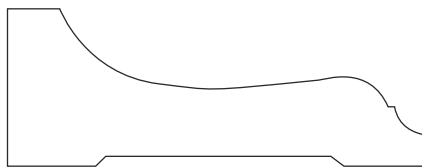

CAS-2010

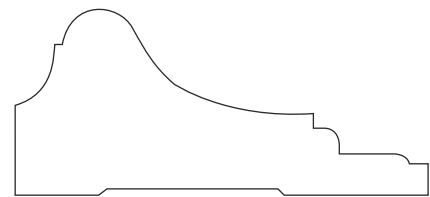

CAS-2011



CAS-2012



CAS-2013



CAS-2014

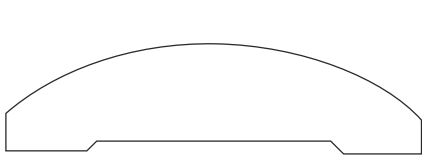

CAS-2015

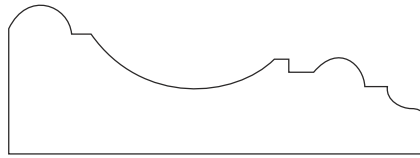

CAS-2016

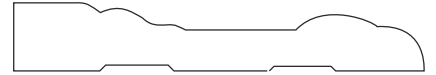

CAS-2017

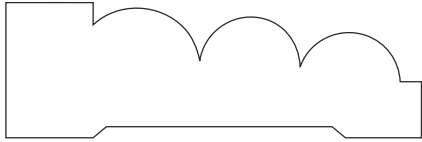

CAS-2018

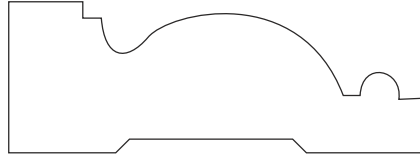

CAS-20119

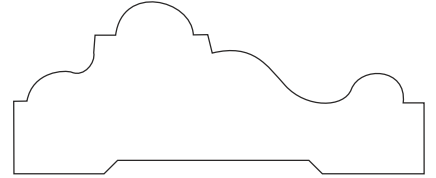

CAS-2020

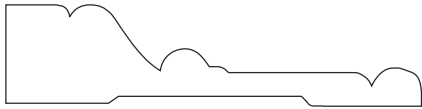

CAS-2021



CAS-2022



CAS-2023

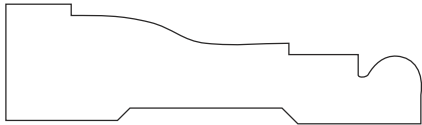

CAS-2024

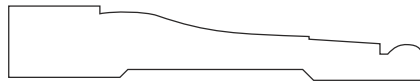

CAS-2025

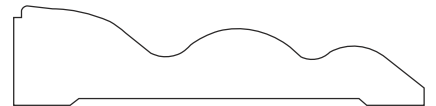

CAS-2026

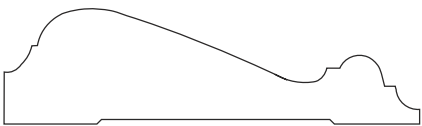

CAS-2027

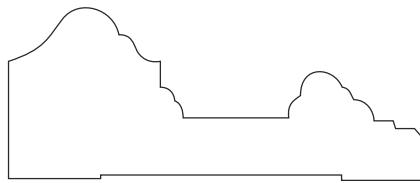

CAS-2028

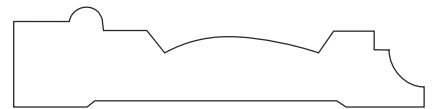

CAS-2029

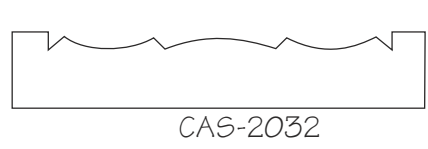
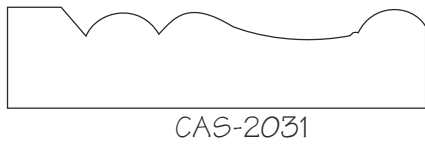
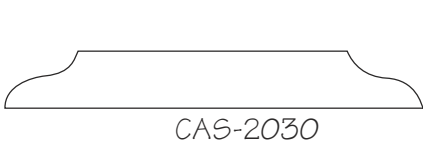

300

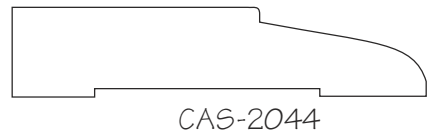
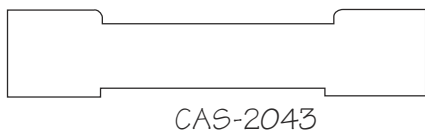
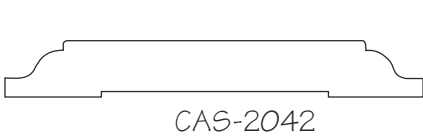
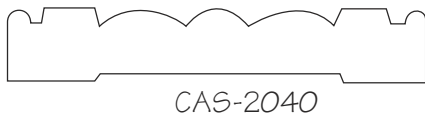
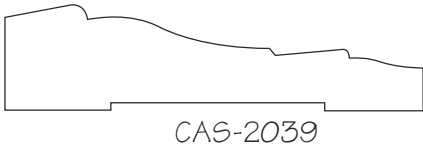
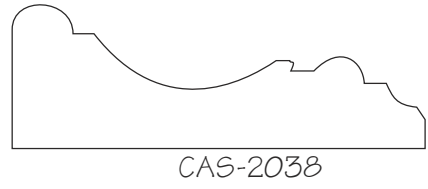
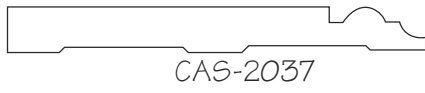
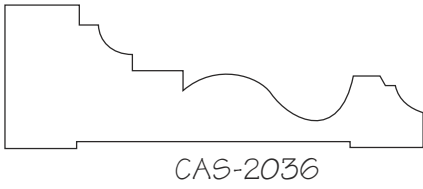
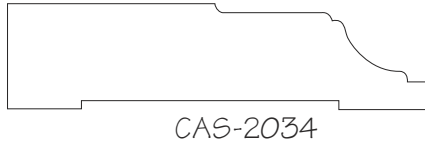
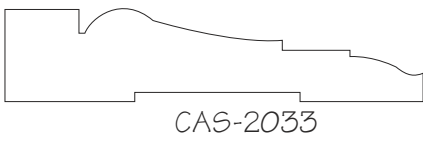

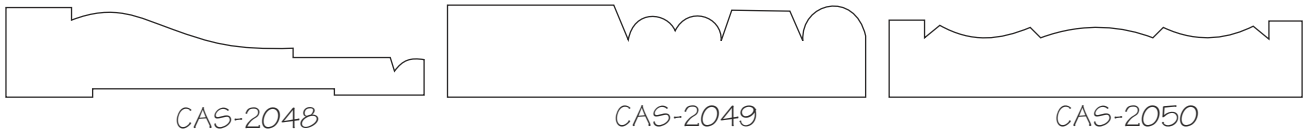
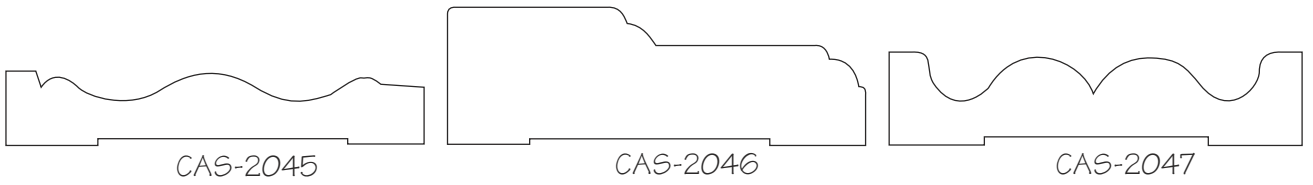

300

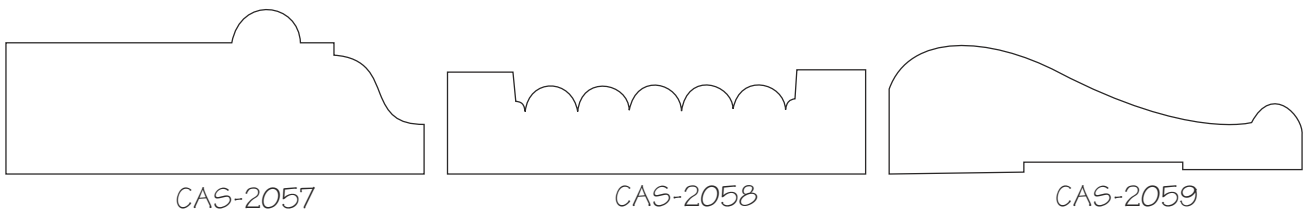
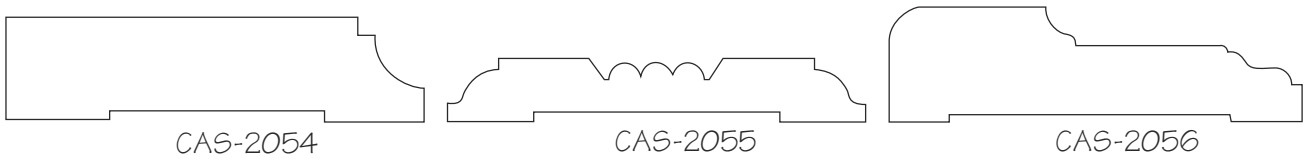
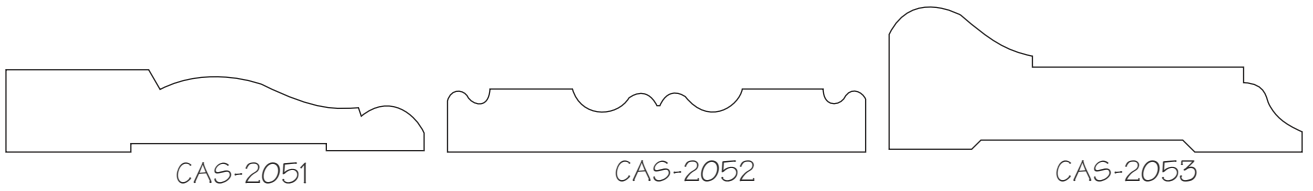

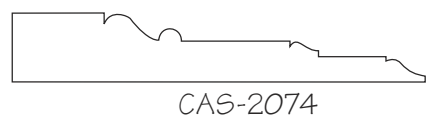
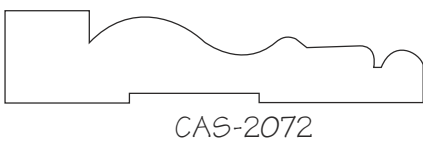
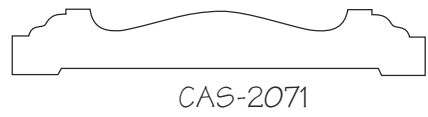
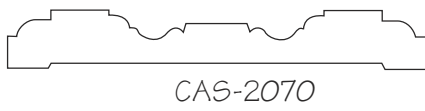
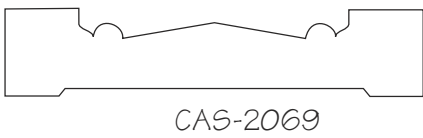
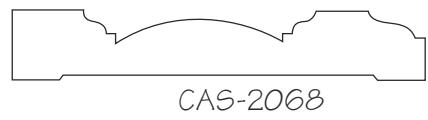
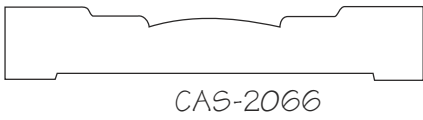
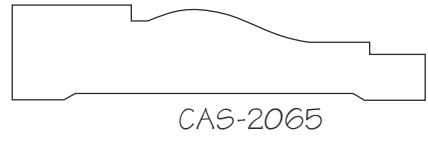
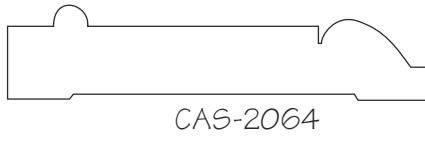
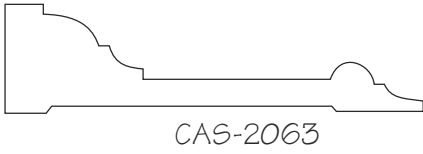
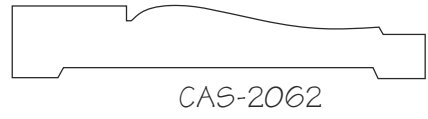
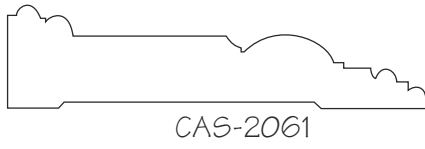
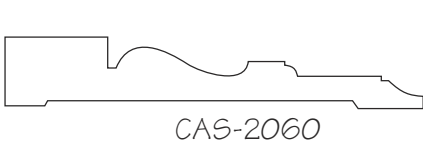

300

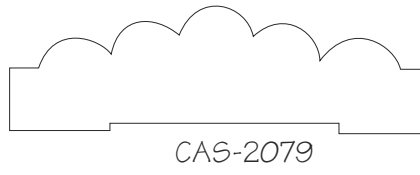
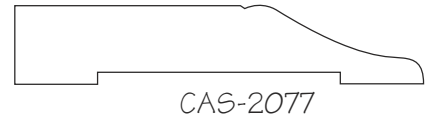
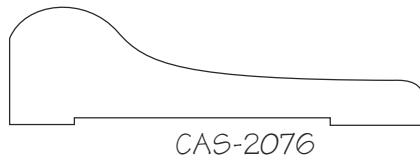

300

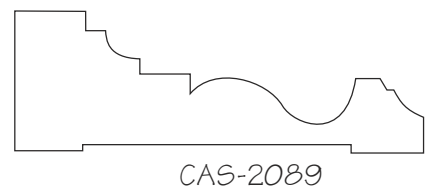
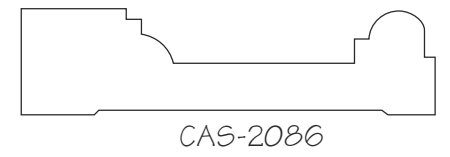
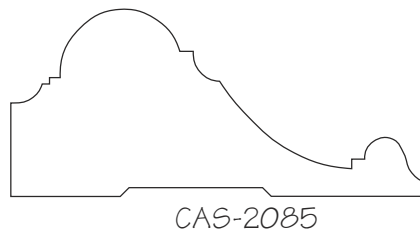
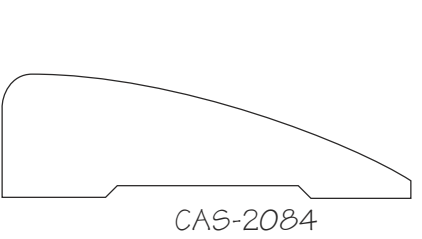
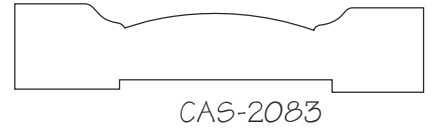
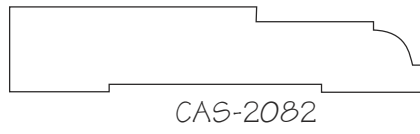
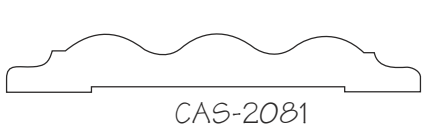

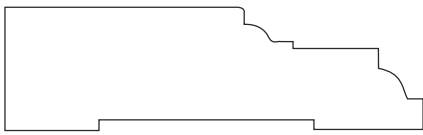

CAS-2090

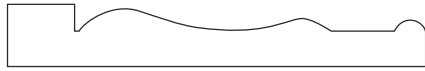

CAS-2091

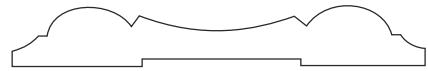

CAS-2092

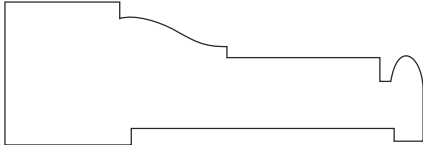

CAS-2093

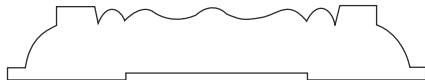

CAS-2094

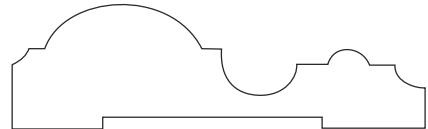

CAS-2095

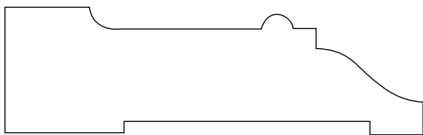

CAS-2096



CAS-2097

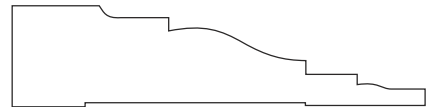

CAS-2098



CAS-2099

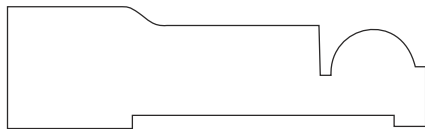

CAS-2100

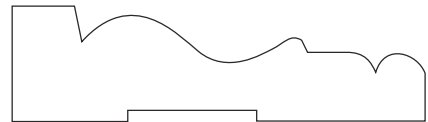

CAS-2101

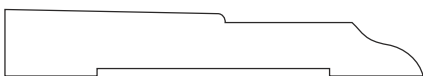

CAS-2102

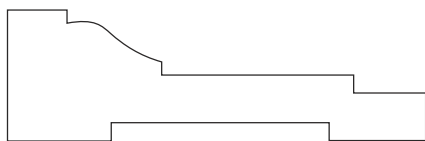

CAS-2103



CAS-2104

300

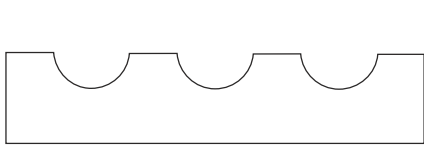

CAS-2105

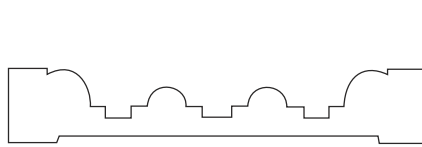

CAS-2106

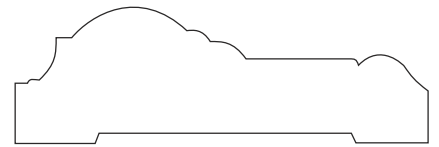

CAS-2107

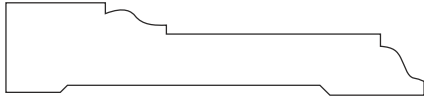

CAS-2108

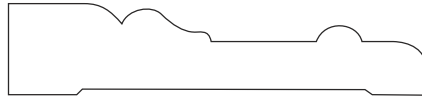

CAS-2109

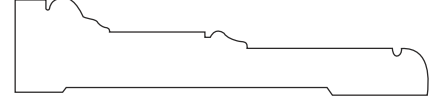

CAS-2110

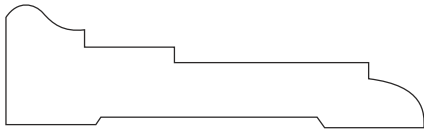

CAS-2111

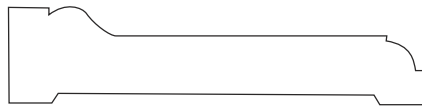

CAS-2112

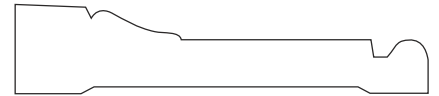

CAS-2113

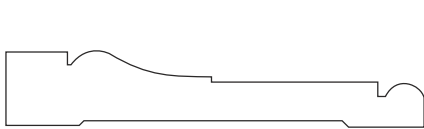

CAS-2114

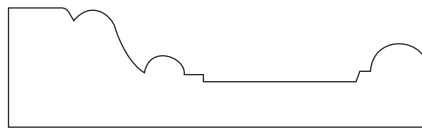

CAS-2115

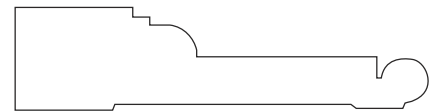

CAS-2116

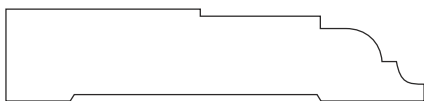

CAS-2117

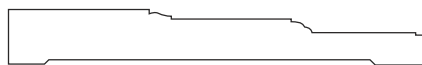

CAS-2118



CAS-2119

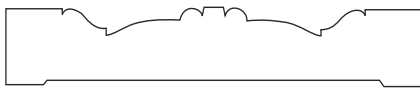

CAS-2120

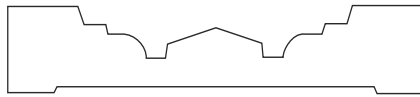

CAS-2121

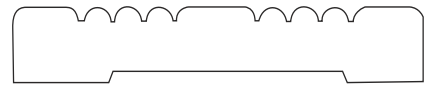

CAS-2122

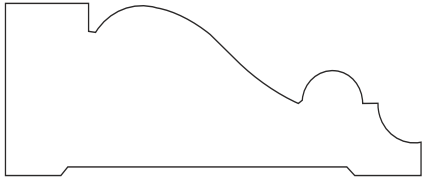

CAS-2123



CAS-2124



CAS-2125

300

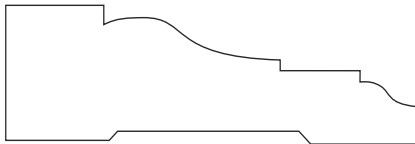

CAS-2126

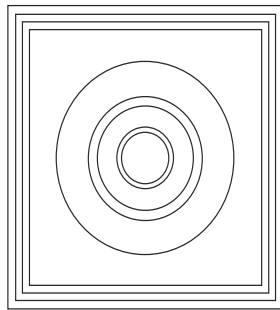

CAS-2727

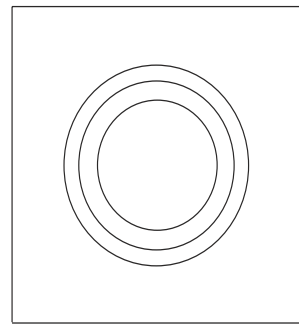
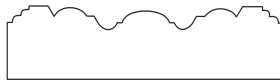

CAS-2728



300-D-6

Panel Mouldings

IMPORTANT NOTE: These drawings are illustrations, not measured or engineered. They are offered for general profile shape only. Some manufacturers may vary the profile or sizes. They are not dimensioned intentionally, allowing the design professional to determine the scale and proportions most appropriate for the project.

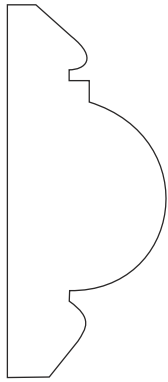

PNL-3000

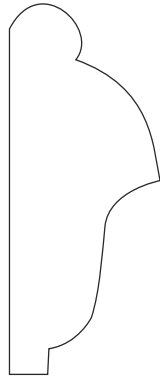

PNL-3001

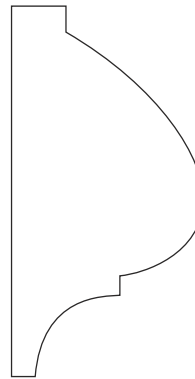

PNL-3002

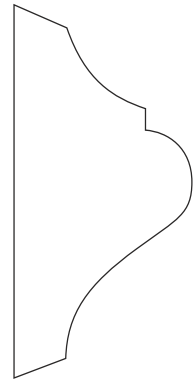

PNL-3003

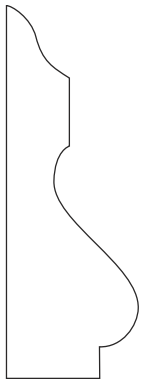

PNL-3004



PNL-3005

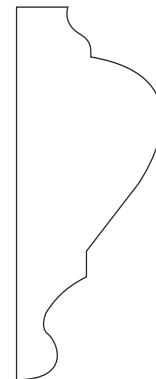

PNL-3006

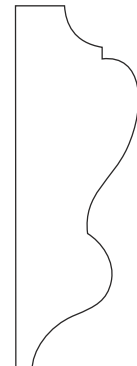

PNL-3007

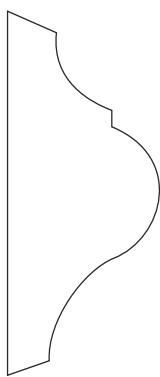

PNL-3008

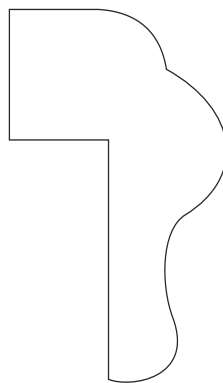

PNL-3009

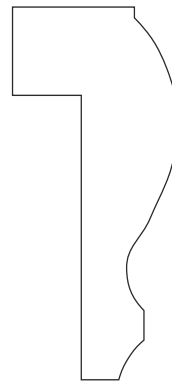

PNL-3010

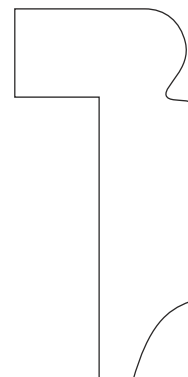

PNL-3011

300-D-7

Crown Mouldings

IMPORTANT NOTE: These drawings are illustrations, not measured or engineered. They are offered for general profile shape only. Some manufacturers may vary the profile or sizes. They are not dimensioned intentionally, allowing the design professional to determine the scale and proportions most appropriate for the project.

300

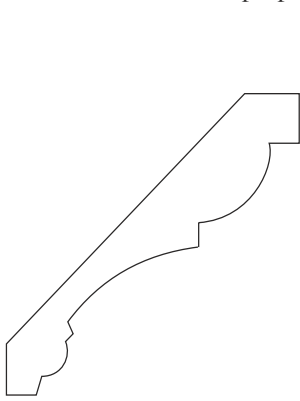

CRN-4000

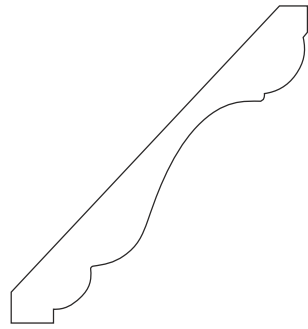

CRN-4001

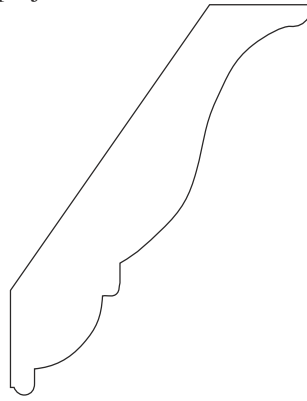

CRN-4002

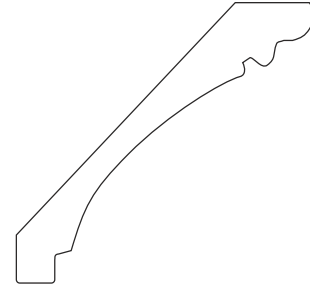

CRN-4003

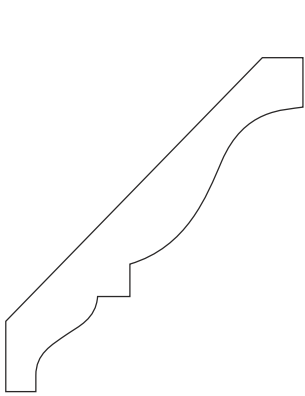

CRN-4004

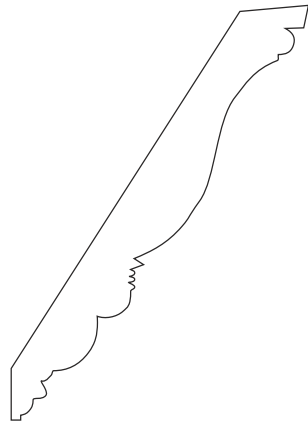

CRN-4005

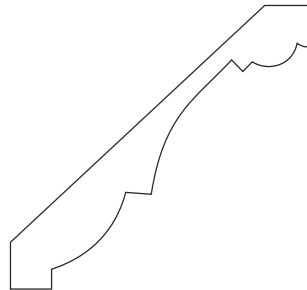

CRN-4006

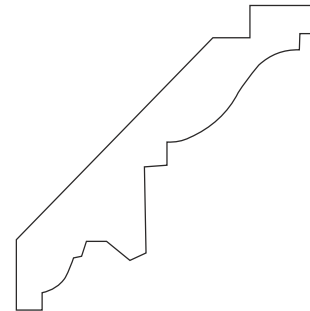

CRN-4007

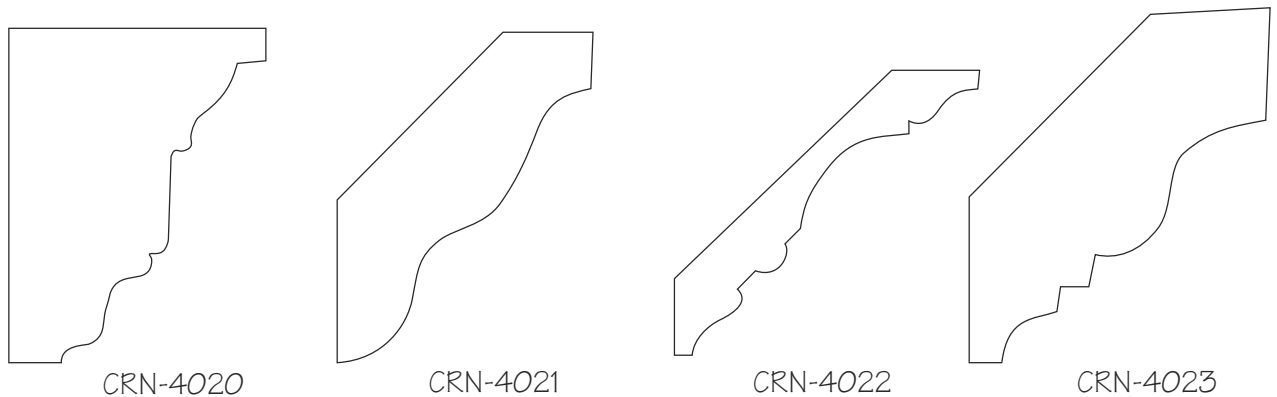
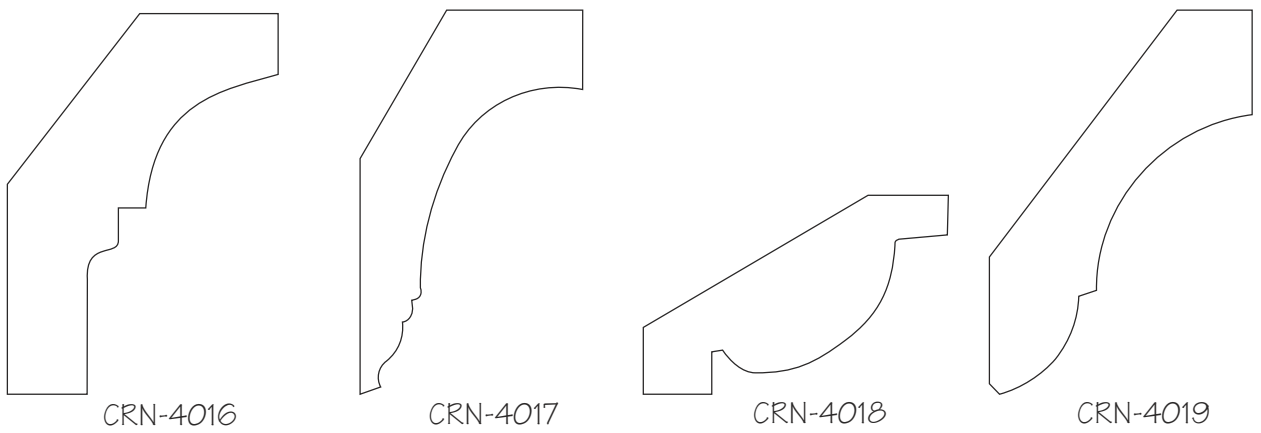
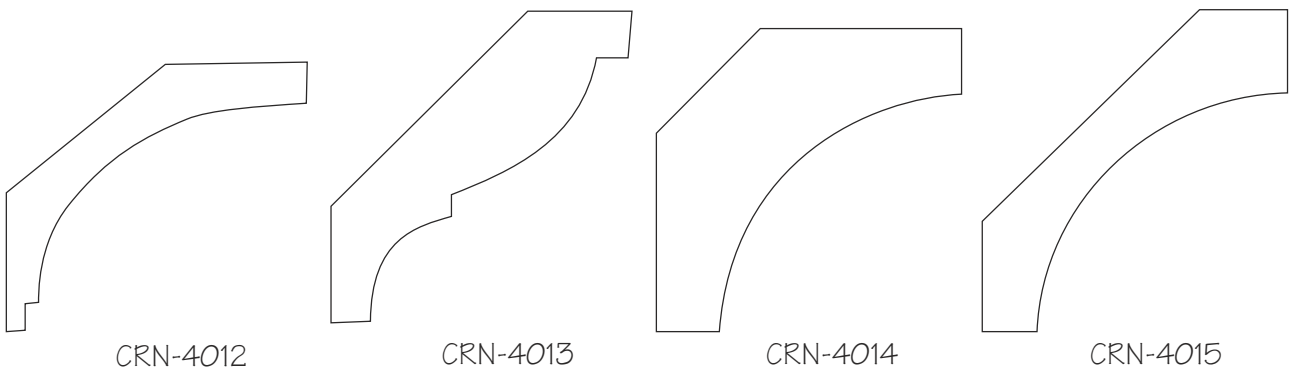
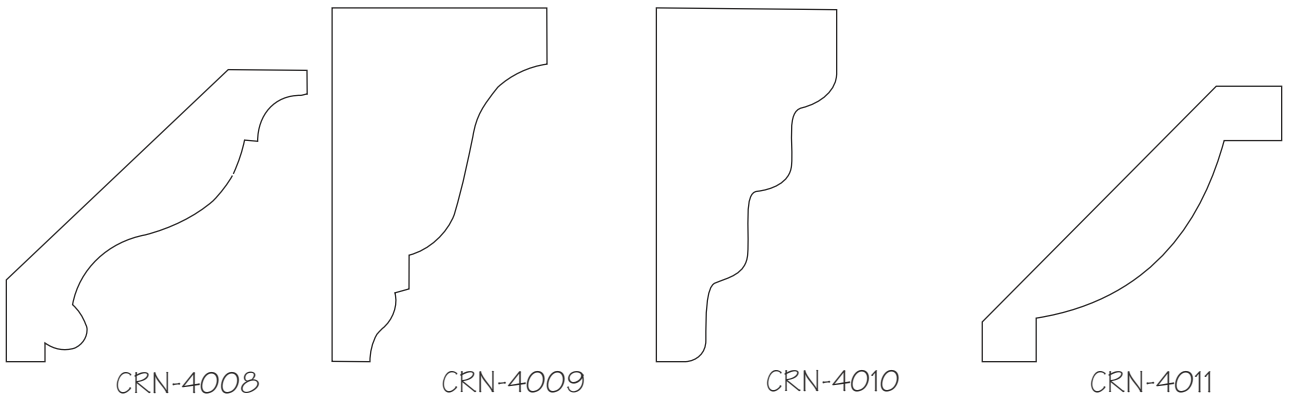

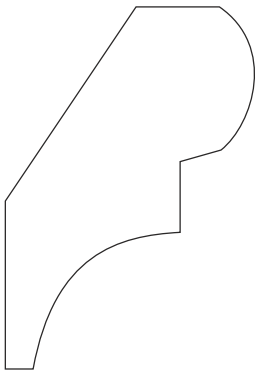

CRN-4024

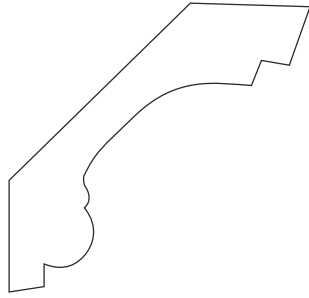

CRN-4025

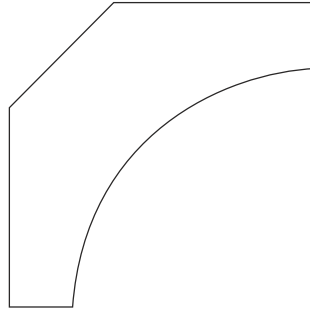

CRN-4026

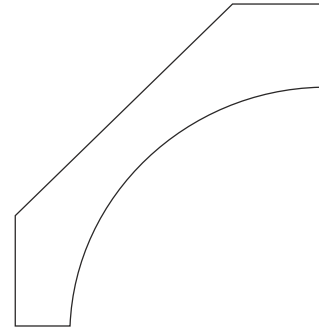

CRN-4027

300

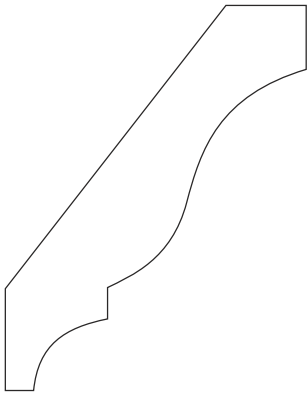

CRN-4028

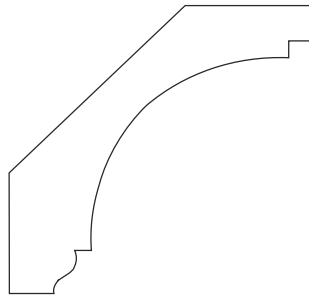

CRN-4029

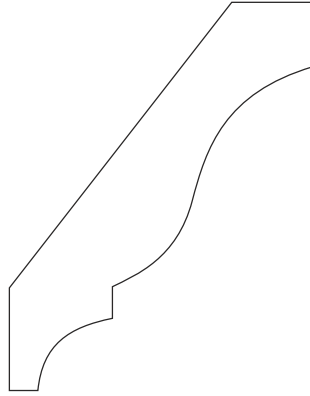

CRN-4030

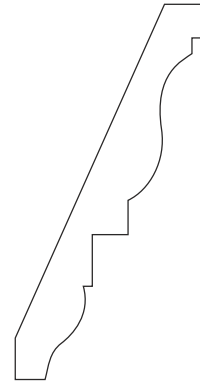

CRN-4031

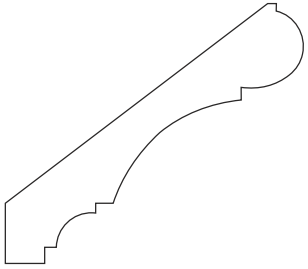

CRN-4032

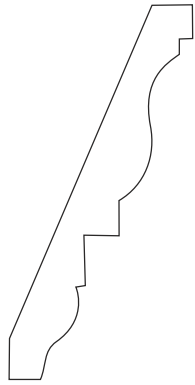

CRN-4033

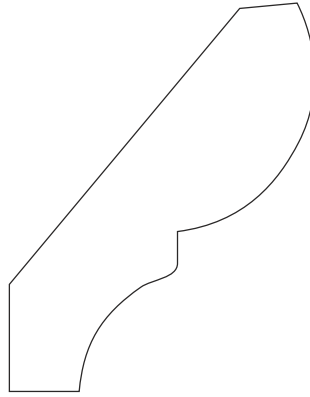

CRN-4034

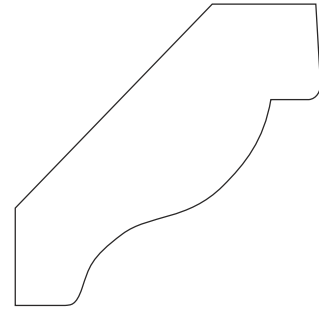

CRN-4035

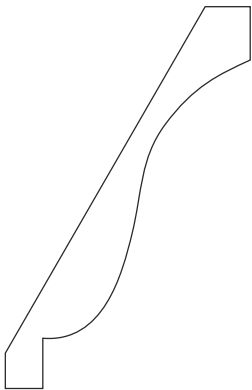

CRN-4036

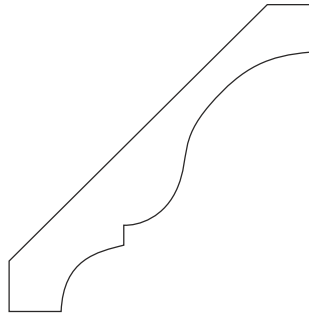

CRN-4037

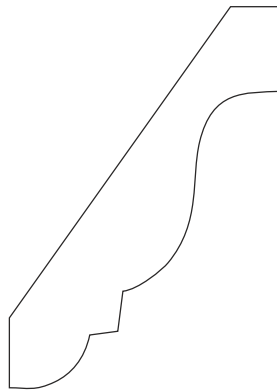

CRN-4038

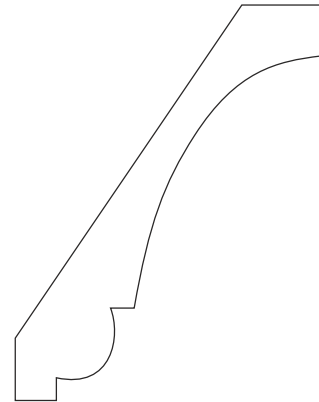

CRN-4039

300-D-8

Handrails

IMPORTANT NOTE: These drawings are illustrations, not measured or engineered. They are offered for general profile shape only. Some manufacturers may vary the profile or sizes. Rails are generally face laminated from multiple boards, rather than run from one piece of solid stock. They are not dimensioned intentionally, allowing the design professional to determine the scale and proportions most appropriate for the project.

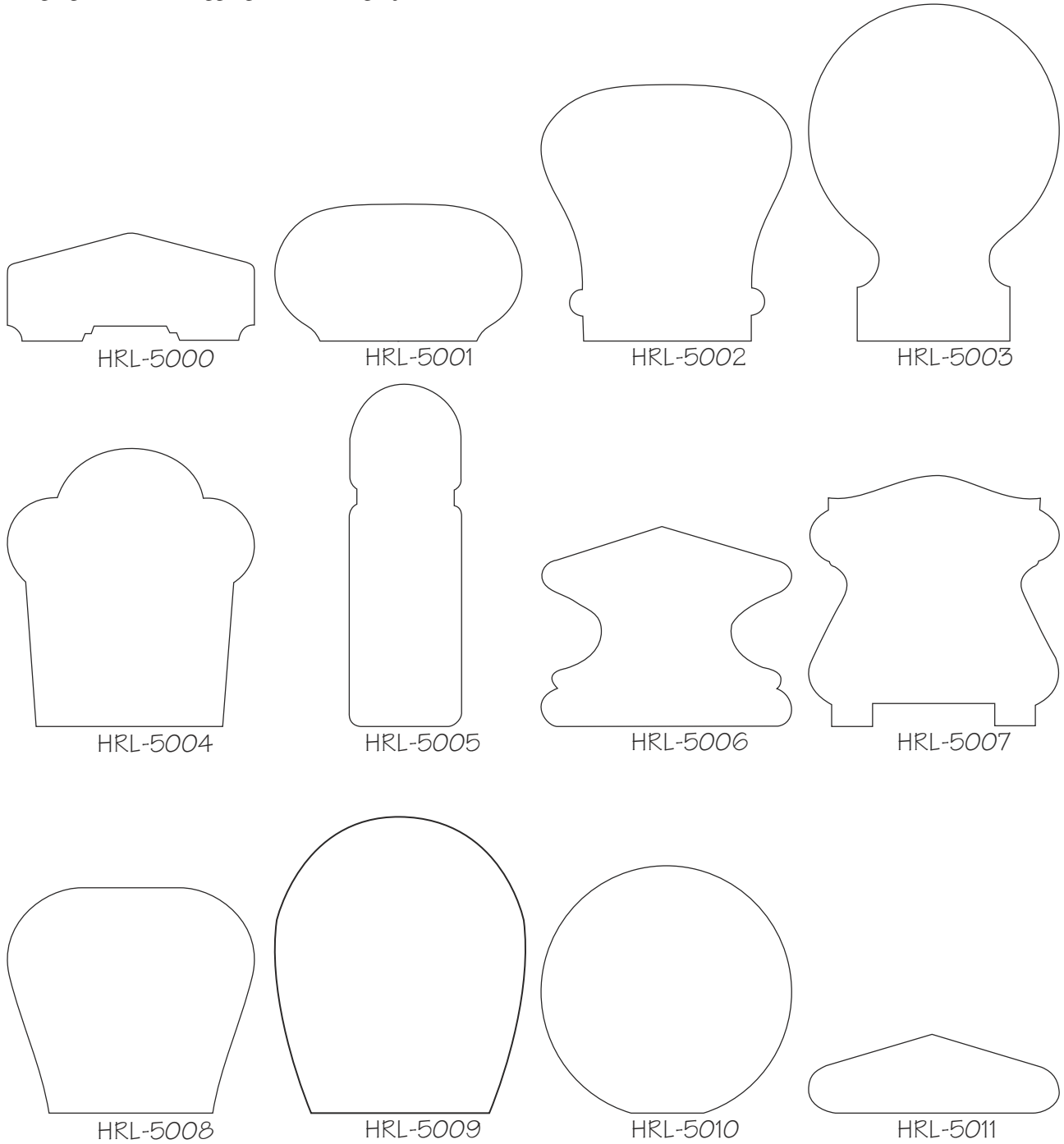

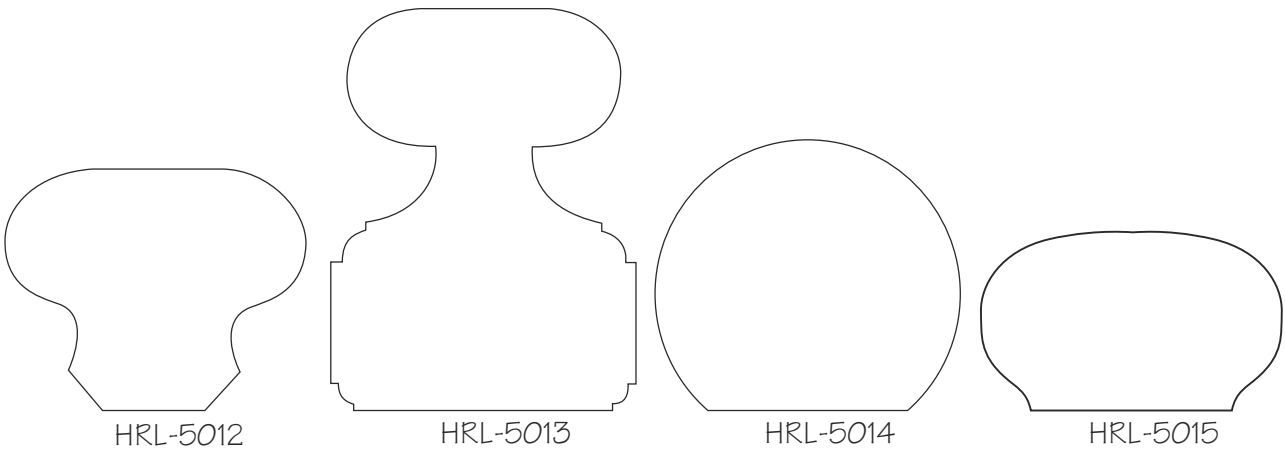

300

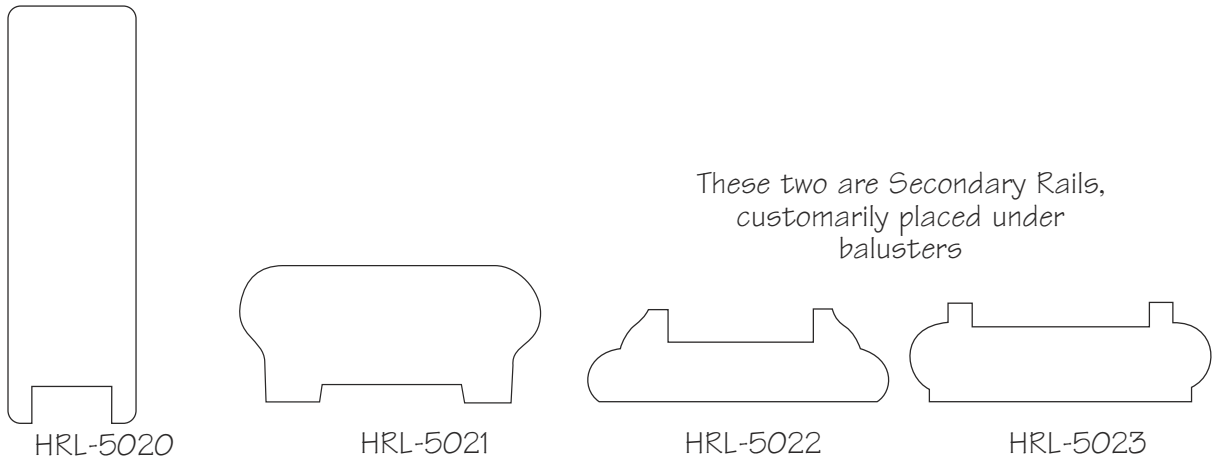
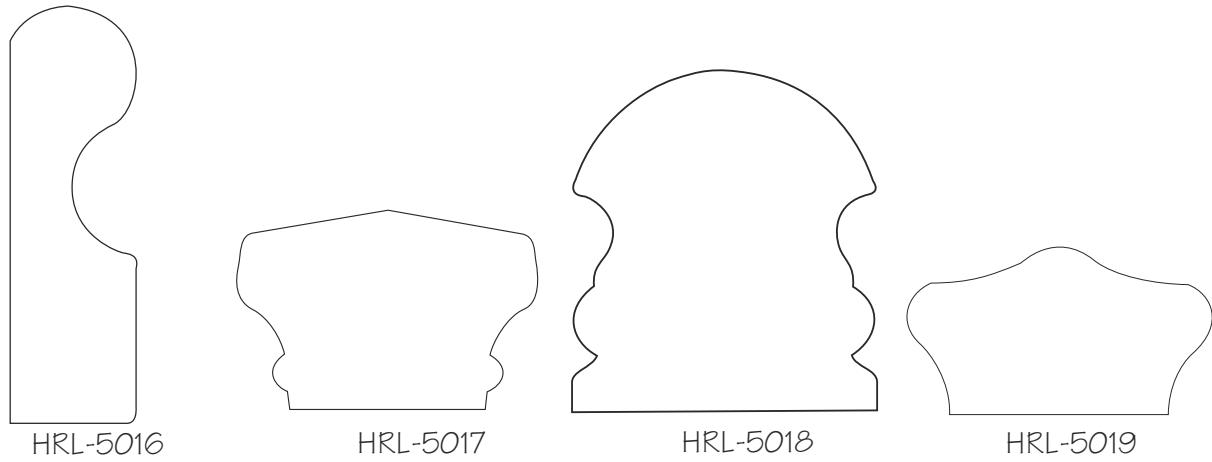

*These two are Secondary Rails,
customarily placed under
balusters*

300-D-9

Chair rails

IMPORTANT NOTE: These drawings are illustrations, not measured or engineered. They are offered for general profile shape only. Some manufacturers may vary the profile or sizes. They are not dimensioned intentionally, allowing the design professional to determine the scale and proportions most appropriate for the project.

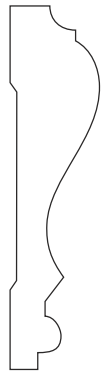

CHR-6000

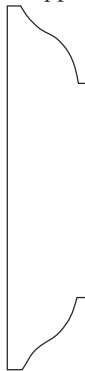

CHR-6001



CHR-6002

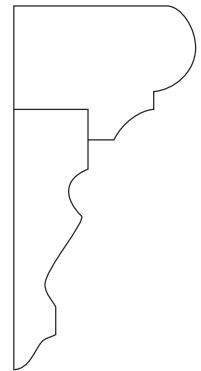

CHR-6003

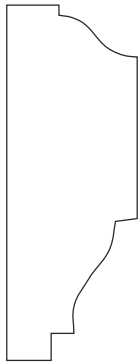

CHR-6004

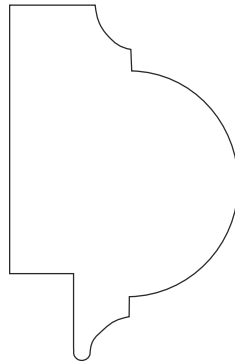

CHR-6005



CHR-6006

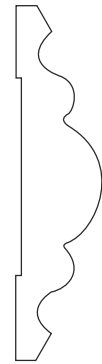

CHR-6007

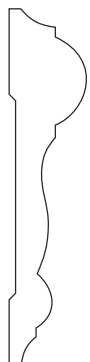

CHR-6008

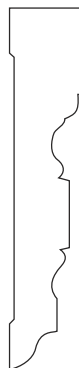

CHR-6009



CHR-6010

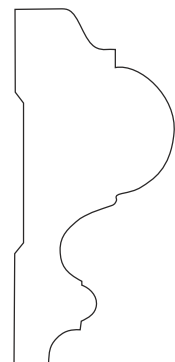

CHR-6011

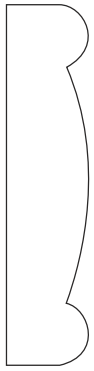

CHR-6012

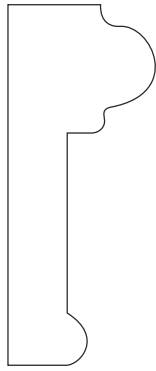

CHR-6013



CHR-6014



CHR-6015

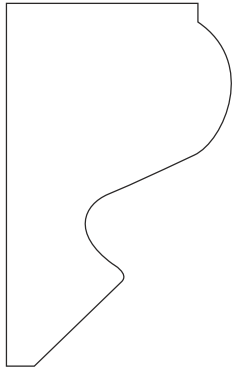

CHR-6016



CHR-6017



CHR-6018

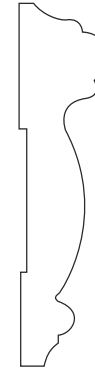

CHR-6019

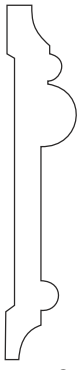

CHR-6020



CHR-6021



CHR-6022



CHR-6023



CHR-6024

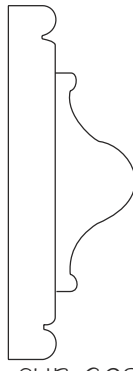

CHR-6025

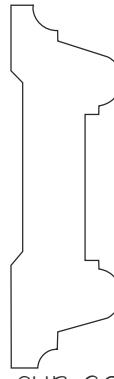

CHR-6026

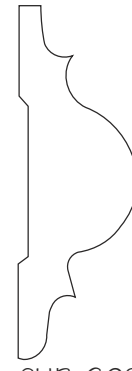

CHR-6027

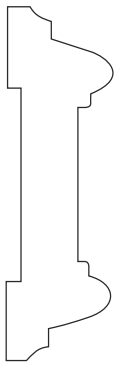

CHR-6028



CHR-6029



CHR-6030

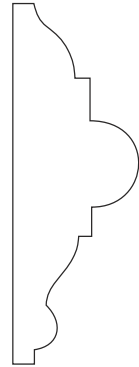

CHR-6031

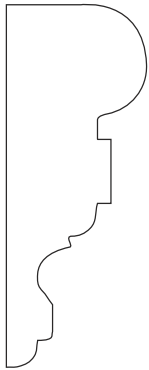

CHR-6032

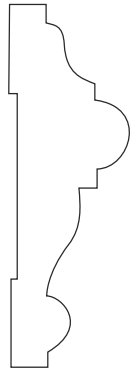

CHR-6033



CHR-6034

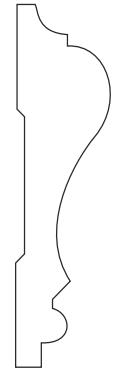

CHR-6035



CHR-6036



CHR-6037



CHR-6038



CHR-6039



CHR-6040

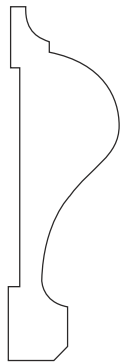

CHR-6041



CHR-6042

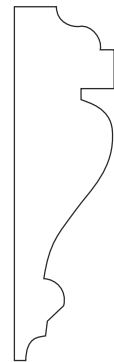

CHR-6043

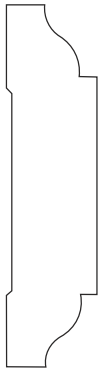

CHR-6044



CHR-6045

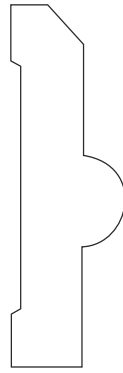

CHR-6046



CHR-6047

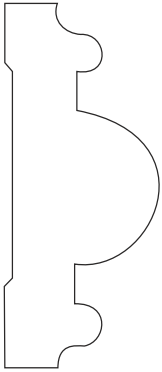

CHR-6048

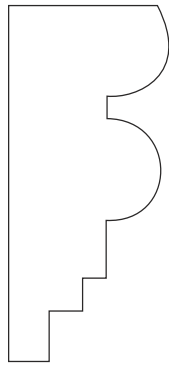

CHR-6049

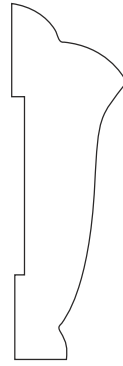

CHR-6050



CHR-6051

300-D-10

Picture Mouldings

IMPORTANT NOTE: These drawings are illustrations, not measured or engineered. They are offered for general profile shape only. Some manufacturers may vary the profile or sizes. They are not dimensioned intentionally, allowing the design professional to determine the scale and proportions most appropriate for the project.

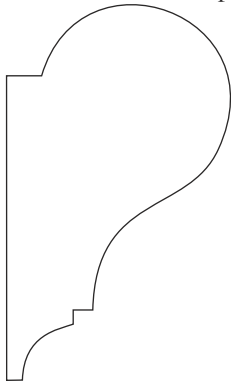

PIC-7000

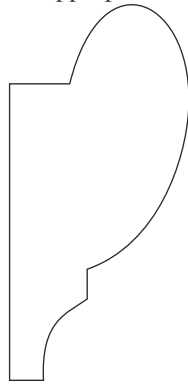

PIC-7001

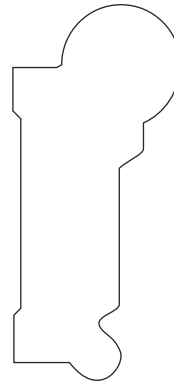

PIC-7002

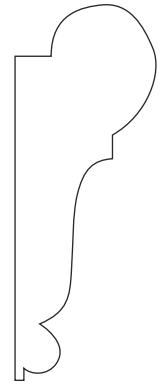

PIC-7003

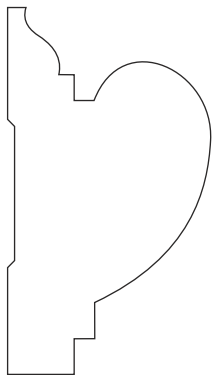

PIC-7004

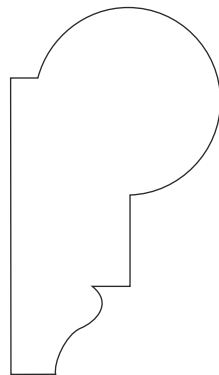

PIC-7005

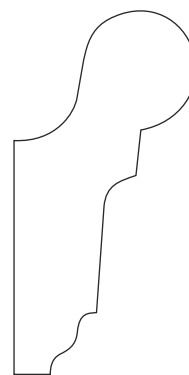

PIC-7006

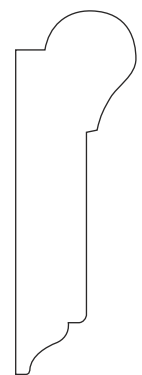

PIC-7007

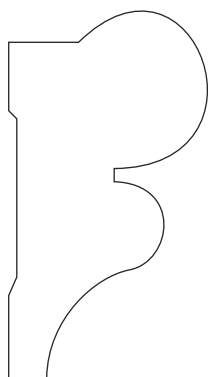

PIC-7008

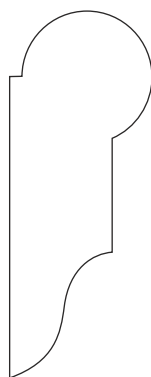

PIC-7009

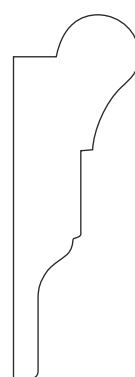

PIC-7010

300-D-11

Personal Notes and Pasted-in Profiles

Use this page to add notes, specifications, and personal profile favorites.